

# NETGEAR®

---

## ReadyNAS 4200 Hardware Manual



350 East Plumeria Drive  
San Jose, CA 95134  
USA

May 2010  
202-10628-01  
v1.0

© 2010 NETGEAR, Inc. All rights reserved.

No part of this publication may be reproduced, transmitted, transcribed, stored in a retrieval system, or translated into any language in any form or by any means without the written permission of NETGEAR, Inc.

## Technical Support

When you register your product at <http://www.netgear.com/register>, we can provide you with faster expert technical support and timely notices of product and software upgrades.

### NETGEAR, Inc.

350 East Plumeria Drive  
San Jose, CA 95134 USA

E-mail: [support@netgear.com](mailto:support@netgear.com)

Website: <http://www.netgear.com>

Phone: 1-888-NETGEAR, for US & Canada only. For other countries, see your Support information card.

## Trademarks

NETGEAR, the NETGEAR logo, ProSafe, Smart Wizard, and Auto Uplink are trademarks or registered trademarks of NETGEAR, Inc. Microsoft, Windows, Windows NT, and Vista are registered trademarks of Microsoft Corporation. Other brand and product names are registered trademarks or trademarks of their respective holders.

## Statement of Conditions

To improve internal design, operational function, and/or reliability, NETGEAR reserves the right to make changes to the products described in this document without notice. NETGEAR does not assume any liability that may occur due to the use or application of the product(s) or circuit layout(s) described herein.

## Revision History

Publication Part Number	Version	Publish Date
202-10628-01	v1.0	May 2010

# Table of Contents

## Chapter 1 Getting Started

Control Panel, Status Displays, Ports, and Drive Bays . . . . .	6
Front Panel . . . . .	6
Disk Tray, Release, and Tray Handle . . . . .	6
Rear Panel . . . . .	7
Rack Mount Setup . . . . .	8
Choosing a Setup Location . . . . .	9
Preparing for Setup . . . . .	9
Installing the System into a Rack. . . . .	9
Initial Setup, IP Address, and Login Password . . . . .	11
Defaults . . . . .	11
Safety Warning . . . . .	12
Electrical Safety Precautions . . . . .	12
General Safety Precautions. . . . .	13
Electrostatic Discharge (ESD) Precautions . . . . .	14
Rack Mount Precautions . . . . .	14

## Chapter 2 Diagnostics and Maintenance

Control Panel Diagnostic and Status Information . . . . .	16
Performing System Shutdown . . . . .	18
Using the Power Button. . . . .	18
Using the FrontView Browser User Interface. . . . .	18
Understanding the System Diagnostics Boot Menu . . . . .	19
Reinstall Firmware using OS Reinstall Option. . . . .	21
Using the Boot Menu to Format a RAID Volume. . . . .	22
Adding or Replacing Disks . . . . .	25
Adding a New Disk . . . . .	25
Failed Disk Notification . . . . .	26
Choosing a Replacement Disk . . . . .	26
Replacing a Failed Disk. . . . .	27
Replacing System Components . . . . .	28
Replacing a System Fan . . . . .	29
Replacing a Power Supply. . . . .	30
Replacing the Onboard Battery . . . . .	30

**Appendix A Default Settings and Specifications**

Factory Default Settings .....32  
Technical Specifications .....33

**Appendix B Notification of Compliance**

**Index**

# Getting Started

---

## ReadyNAS 4200

# 1

This chapter provides an overview of the unit's physical features.

Topics discussed in this chapter include:

- [Control Panel, Status Displays, Ports, and Drive Bays](#)
- [Rack Mount Setup](#)
- [Choosing a Setup Location](#)
- [Initial Setup, IP Address, and Login Password](#)
- [Safety Warning](#)

## Control Panel, Status Displays, Ports, and Drive Bays

This section introduces the ReadyNAS control panel, status display, ports, and disk bays.

### Front Panel

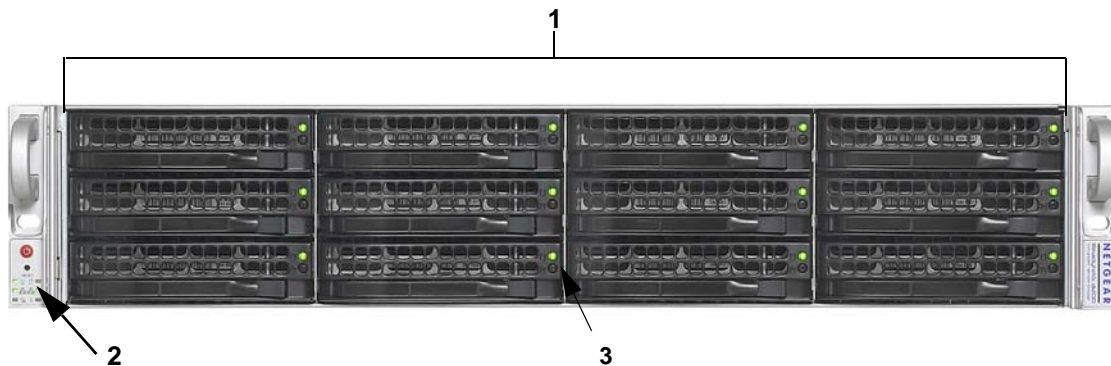

1. Twelve disk bays with hot-pluggable disk trays that each include two status lights.
2. Control panel with status lights
  - Power and Reset buttons
  - Power, LAN, disk, and fan status lights
3. Status lights
  - Green: Disk present and activity light
  - Amber or off: Disk failure light

### Disk Tray, Release, and Tray Handle

The disk tray features a push switch-activated pop-out tray handle.



#### WARNING!

Regardless of how many hard drives are installed, all drive trays must remain in the drive bays to maintain proper airflow.

## Rear Panel

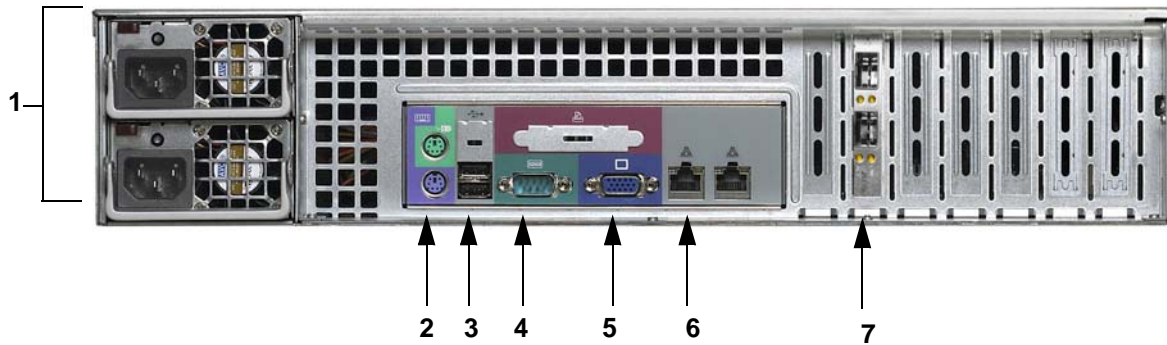

1. Dual power supplies
2. PS2 keyboard and mouse ports
3. Two USB ports
4. RS232 console port
5. VGA monitor port
6. Two Gigabit Ethernet ports with failover and link aggregation
7. Two 10 G Ethernet ports

## Rack Mount Setup

Use the included rack mount hardware to install the unit according to the following instructions.



### **DANGER:**

A unit with installed drives can weigh more than 80 pounds. So as to avoid injury or damage to the equipment, plan to perform the rack mount installation with appropriate assistance.

### ***Ambient Operating Temperature***

If the unit installed in a closed or multi-unit rack assembly, the ambient operating temperature of the rack environment might be greater than the ambient temperature of the room. Therefore, consideration should be given to installing the equipment in an environment compatible with the maximum rated ambient temperature found in "[Default Settings and Specifications](#)" in Appendix A.

### ***Reduced Airflow***

Equipment should be mounted into a rack so that the amount of airflow required for safe operation is not compromised.

### ***Mechanical Loading***

Equipment should be mounted into a rack so that a hazardous condition does not arise due to uneven mechanical loading.

### ***Circuit Overloading***

Consideration should be given to the connection of the equipment to the power supply circuitry and the effect that any possible overloading of circuits might have on over current protection and power supply wiring. Consider equipment nameplate ratings when addressing this concern.

### ***Reliable Ground***

A reliable ground must be maintained at all times. To ensure this, the rack itself should be grounded. Particular attention should be given to power supply connections other than the direct connections to the branch circuit (for example, the use of power strips).



## Choosing a Setup Location

---

**Note:** This product is intended for installation in a restricted access location (dedicated equipment rooms, service closets, and the like) only.

---

Leave enough clearance in front of the rack to enable you to open the front door completely (about 25 inches) and approximately 30 inches of clearance in the back of the rack to allow for sufficient airflow and ease in servicing.

## Preparing for Setup

Read these instructions in their entirety before you begin. Locate the ReadyNAS 4200 shipping carton, remove the rack mounting kit and prepare to work with it.

## Installing the System into a Rack

**To install the system into a rack:**

1. The rack mounting kit contains two rail assemblies. Each assembly consists of two sections: an inner fixed chassis rail that secures directly to the ReadyNAS 4200 chassis and an outer fixed rack rail that secures directly to the rack itself. Extend the rail assembly by pulling it outward. Press the release tab and separate the inner rail from the outer assembly.

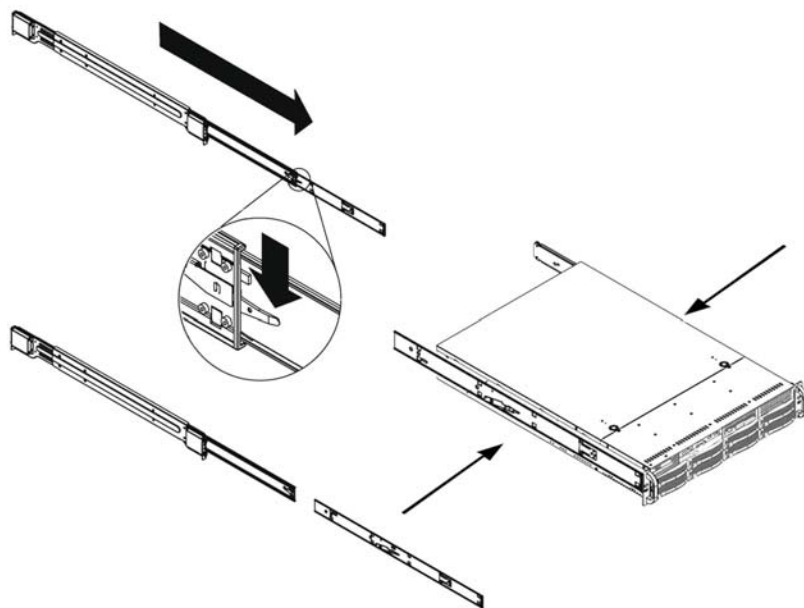

2. Use the provided mounting screws to mount the inner rails to the system chassis.
3. Fasten the backs of the outer rails to the rack with screws. Press the release to extend the rails. Hang the hooks of the rails into the rack holes, and fasten the rails to the rack.

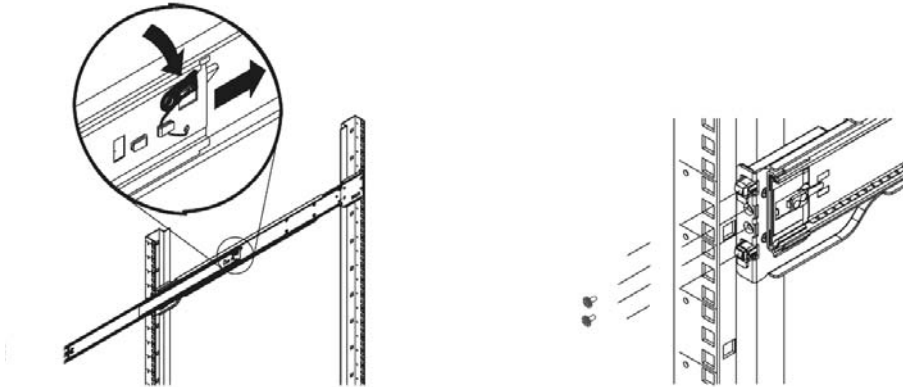

4. Attach chassis to the rack.
  - a. Extend the ball shuttle (A) to the very front.
  - b. Align the rails (B) and push the chassis in.
  - c. Secure the handles to the outer rails (C) with screws.

The rack mount installation is complete.

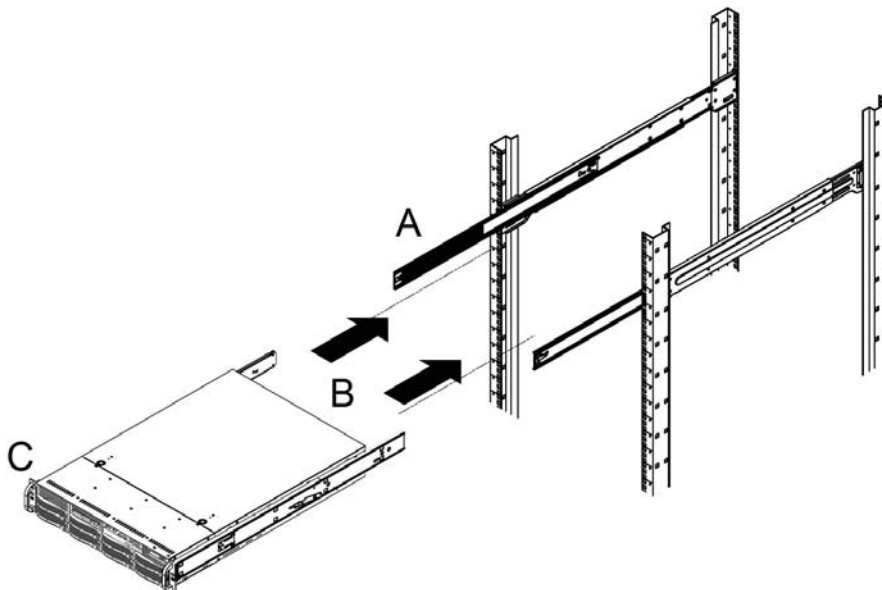

## Initial Setup, IP Address, and Login Password

Follow the instructions in the *NETGEAR ReadyNAS Installation Guide* that came with your unit to install it. An electronic copy of the installation guide is on the product CD, on the NETGEAR website, and on <http://readynas.com/documentation>.

### Defaults

Estimated setup time is about 20 minutes.

- Default IP configuration: set to DHCP; if the unit does not get an IP address, it defaults to 192.168.168.168.
- Default administrator user name: **admin**
- Default password: **netgear1**

Both the user name and password are case-sensitive.

For information about using ReadyNAS 4200 RAIDar and FrontView software to log in, configure, and manage your system, see the *ReadyNAS for Business Software Manual*.

## Safety Warning

1. The equipment contains no operator access areas and is certified for installation only by trained personnel, according to the installation instructions provided with each unit.
2. The socket-outlet shall be installed near the equipment and shall be easily accessible.
3. Observe the onboard battery precautions. Follow the battery replacement instructions from *“Replacing the Onboard Battery”* on page 30.



### DANGER:

RISK OF EXPLOSION IF BATTERY IS REPLACED BY AN INCORRECT TYPE. DISPOSE OF USED BATTERIES ACCORDING TO THEIR INSTRUCTIONS.

4. The units and their associated LAN connections shall be interconnected only with equipment within the same building.
5. Slide or rail mounted equipment is not to be used as a shelf or a work space. 

## Electrical Safety Precautions

Follow basic electrical safety precautions to protect yourself from harm and the ReadyNAS 4200 from damage:

- Be aware of the locations of the power on/off switch on the chassis as well as the room's emergency power-off switch, disconnection switch, or electrical outlet. If an electrical accident occurs, you can then quickly remove power from the system.
- Do not work alone when working with high voltage components.
- Always disconnect power from the system when removing or installing main system components, such as the main board or memory modules. When disconnecting power, you should first power down the system with the operating system and then unplug the power cords of all the power supply units in the system.
- When working around exposed electrical circuits, another person who is familiar with the power-off controls should be nearby to switch off the power if necessary.
- Use only one hand when working with powered-on electrical equipment. This is to avoid making a complete circuit, which will cause electrical shock. Use extreme caution when using metal tools, which can easily damage any electrical components or circuit boards they come into contact with.
- Do not use mats designed to decrease static electrical discharge as protection from electrical shock. Instead, use rubber mats that have been specifically designed as electrical insulators.
- The power supply cords must include a grounding plug and must be plugged into grounded electrical outlets.

## General Safety Precautions

Follow these rules to ensure general safety:

- Keep the area around the ReadyNAS 4200 clean and free of clutter.
- The ReadyNAS 4200 weighs approximately 82 pounds when fully loaded. When lifting the system, two people at either end should lift slowly with their feet spread out to distribute the weight. Always keep your back straight and lift with your legs.
- Place the chassis top cover and any system components that have been removed away from the system or on a table so that they will not accidentally be stepped on.
- While working on the system, do not wear loose clothing such as neckties and unbuttoned shirt sleeves, which can come into contact with electrical circuits or be pulled into a cooling fan.
- Remove any jewelry or metal objects from your body, which are excellent metal conductors that can create short circuits and harm you if they come into contact with printed circuit boards or areas where power is present.
- Onboard battery: This battery must be replaced only with the same or an equivalent type recommended by the manufacturer. Dispose of used batteries according to the manufacturer's instructions.



**DANGER:**

There is a danger of explosion if the onboard battery is installed upside down, which will reverse its polarities.

- Main board replaceable soldered-in fuses: Self-resetting PTC (positive temperature coefficient) fuses on the main board must be replaced by trained service technicians only. The new fuse must be the same as or equivalent to the one replaced. Contact technical support for details and support.

## Electrostatic Discharge (ESD) Precautions

Electrostatic discharge is generated by two objects with different electrical charges coming into contact with each other. An electrical discharge is created to neutralize this difference, which can damage electronic components and printed circuit boards. The following measures are generally sufficient to neutralize this difference before contact is made to protect your equipment from ESD:



- Use a grounded wrist strap designed to prevent static discharge.
- Keep all components and printed circuit boards (PCBs) in their antistatic bags until ready for use.
- Touch a grounded metal object before removing the board from the antistatic bag.
- Do not let components or PCBs come into contact with your clothing, which might retain a charge even if you are wearing a wrist strap.
- Handle a board by its edges only; do not touch its components, peripheral chips, memory modules, or contacts.
- When handling chips or modules, avoid touching their pins.
- Put the main board and peripherals back into their antistatic bags when not in use.
- For grounding purposes, make sure your computer chassis provides excellent conductivity between the power supply, the case, the mounting fasteners and the main board.
- After accessing the inside of the system, close the system back up and secure it to the rack unit with the retention screws after ensuring that all connections have been made.

## Rack Mount Precautions

Follow these rack mount precautions:

- Ensure that the leveling jacks on the bottom of the rack are fully extended to the floor with the full weight of the rack resting on them.
- In single-rack installations, stabilizers should be attached to the rack. In multiple-rack installations, the racks should be coupled together.
- Always make sure the rack is stable before extending a component from the rack.
- You should extend only one component at a time; extending two or more simultaneously might cause the rack to become unstable.
- Determine the placement of each component in the rack *before* you install the rails.
- Install the heaviest components on the bottom of the rack first, and then work up.
- Use a regulating uninterruptible power supply (UPS) to protect the ReadyNAS 4200 from power surges, and voltage spikes and to keep your system operating in case of a power failure.
- Allow any hot-plug drives and power supply modules to cool before touching them.
- Always keep the rack's front door and all panels and components on the servers closed when not servicing to maintain proper cooling.

# 2 Diagnostics and Maintenance

---

# 2





This chapter includes topics on system status, system shutdown, using the diagnostics menu, and adding, replacing, or formatting disks.

- [Control Panel Diagnostic and Status Information](#)
- [Performing System Shutdown](#)
- [Understanding the System Diagnostics Boot Menu](#)
- [Reinstall Firmware using OS Reinstall Option](#)
- [Using the Boot Menu to Format a RAID Volume](#)
- [Adding or Replacing Disks](#)
- [Replacing System Components](#)







## Control Panel Diagnostic and Status Information

The control panel for the ReadyNAS 4200 is located on the bottom left corner of the unit. Each function on the control panel is described in the table below.



Item	Activity	Description
<b>Power button</b> 	Push button	Push to turn on the ReadyNAS 4200. The power LED blinks while the ReadyNAS 4200 is booting.  <b>Preferred shutdown:</b> If the unit is running, pressing the power button once will begin the graceful shutdown blink pattern on the LEDs. Pressing the power button a second time within 5 seconds confirms and initiates the graceful shutdown.  <b>Forced shutdown:</b> If the unit is hung, you can press and hold the power button for 5 seconds to force shutdown.
<b>System Reset</b> 	Push button	<b>Reset:</b> Use a stick pin or paper clip to press the reset button once to do a warm boot of the ReadyNAS 4200.  <b>Diagnostics:</b> To enter the diagnostic boot menu, see <a href="#">“Understanding the System Diagnostics Boot Menu”</a> on page 19.
<b>Power LED</b> 	On (Green) Off	<b>Green:</b> The unit is powered on. <b>Off:</b> The unit is powered off.
<b>Disk LED</b> 	On/Blink (Amber)	<b>Blinking amber:</b> Disk activity.



Item	Activity	Description
<b>LAN LEDs</b> 	On (Green) Blink (Green) Off	<b>Green:</b> Power is on and LAN cable connected. <b>Blink green:</b> LAN activity. <b>Off:</b> LAN cable disconnected.
<b>Power diagnostic LED</b> 	On (Red) Off	<b>Red:</b> Power failure. <b>Off:</b> Normal operation.
<b>FAN LED</b> 	On (Red) Off	<b>Red:</b> Overheating or fan failure. <b>Off:</b> Normal operation.
<b>Upper disk tray LED: disk presence</b> 	On (Green) Blink (Green) Off	<b>Green:</b> Unit is on and disk installed. <b>Blinking green:</b> Volume activity. <b>Off:</b> No disk installed, or no volume present.
<b>Lower disk tray LED: disk failure</b> 	On (Amber) Off	<b>On:</b> Disk failed. <b>Off:</b> If a disk is installed, the disk operation is normal.
<b>Rear panel Ethernet Ports</b> 	On (Green) On (Amber) Off	<b>Green:</b> The LAN port is operating at 1,000 Mbps. <b>Amber:</b> The LAN port is operating at 100 Mbps. <b>Off:</b> The LAN port is operating at 10 Mbps.
<b>Rear panel 10Gb ports; CX4 or SFP</b> 	On (Green) On (Amber) Off	<b>Green:</b> The port is operating at 10 Gb link speed. <b>Blinking green:</b> Indicates activity on the port. <b>Amber:</b> The port is operating at 1 Gb link speed. <b>Off:</b> No activity.

## Performing System Shutdown

You can shut down the unit using the power button, or from the FrontView browser user interface.

### Using the Power Button

There are two ways to shut down the unit using the power button.

- **Preferred shutdown:** Pressing the power button twice initiate a graceful shutdown.
- **Forced shutdown:** If the unit is hung, hold the power button for 5 seconds to force shutdown.

### Using the FrontView Browser User Interface

The **FrontView > Shutdown Options** screen offers the option to power off or reboot the ReadyNAS 4200. You also have the option of performing a full file system check or a quota check on the next boot.

## Understanding the System Diagnostics Boot Menu

This section introduces the system diagnostics boot menu.

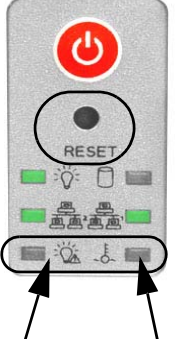
Control Panel	Selecting Boot Menu Options																																																																																																													
 <p data-bbox="248 783 321 863">Red Power LED</p> <p data-bbox="375 783 431 863">Red Fan LED</p>	<p data-bbox="448 426 764 453">To select a boot menu option:</p> <ol data-bbox="448 457 1419 716" style="list-style-type: none"> <li data-bbox="448 457 1419 537">1. Enable the boot menu by using a paper clip to hold in the <b>Reset</b> button while powering the unit on. Keep pressing Reset for up to 1 minute until both the red LEDs at the bottom are lit.</li> <li data-bbox="448 541 1419 653">2. Press the <b>Reset</b> button within 2 seconds to step through the <b>Boot Menu</b> options. The system presents the blink pattern of the selected boot menu option, and holds the display of the final LEDs in the pattern (either off on, or on on), and waits for you to confirm the selection.</li> <li data-bbox="448 657 1419 716">3. Press and hold the <b>Reset</b> button for 3 seconds to confirm the selection. The system confirms the selection by blinking both LEDs twice, then proceeds.</li> </ol> <table border="1" data-bbox="467 800 1403 1262"> <thead> <tr> <th data-bbox="475 810 732 837">Boot Menu Sequence</th> <th colspan="8" data-bbox="792 810 1344 837">Red Power LED and Red Fan LED Blink Patterns</th> </tr> </thead> <tbody> <tr> <td data-bbox="475 856 732 884">LED Legend:</td> <td data-bbox="792 856 862 884">■ ■</td> <td data-bbox="862 856 932 884">■ ■</td> <td data-bbox="932 856 1002 884">■ ■</td> <td data-bbox="1002 856 1071 884">■ ■</td> <td data-bbox="1071 856 1141 884">■ ■</td> <td data-bbox="1141 856 1211 884">■ ■</td> <td data-bbox="1211 856 1281 884">■ ■</td> <td data-bbox="1281 856 1351 884">■ ■</td> <td data-bbox="1351 856 1403 884">■ ■</td> </tr> <tr> <td></td> <td data-bbox="792 888 862 915">Off</td> <td data-bbox="862 888 932 915">Off</td> <td data-bbox="932 888 1002 915">On</td> <td data-bbox="1002 888 1071 915">On</td> <td data-bbox="1071 888 1141 915">Off</td> <td data-bbox="1141 888 1211 915">On</td> <td data-bbox="1211 888 1281 915"></td> <td data-bbox="1281 888 1351 915"></td> <td data-bbox="1351 888 1403 915"></td> </tr> <tr> <td data-bbox="475 930 732 957">Boot Menu Enabled</td> <td data-bbox="792 930 862 957">■ ■</td> <td data-bbox="862 930 932 957">■ ■</td> <td data-bbox="932 930 1002 957">■ ■</td> <td data-bbox="1002 930 1071 957">■ ■</td> <td data-bbox="1071 930 1141 957">■ ■</td> <td data-bbox="1141 930 1211 957">■ ■</td> <td data-bbox="1211 930 1281 957">■ ■</td> <td data-bbox="1281 930 1351 957">■ ■</td> <td data-bbox="1351 930 1403 957">■ ■</td> </tr> <tr> <td data-bbox="475 972 732 999">1. Normal Boot</td> <td data-bbox="792 972 862 999">■ ■</td> <td data-bbox="862 972 932 999">■ ■</td> <td data-bbox="932 972 1002 999">■ ■</td> <td data-bbox="1002 972 1071 999">■ ■</td> <td data-bbox="1071 972 1141 999">■ ■</td> <td data-bbox="1141 972 1211 999">■ ■</td> <td data-bbox="1211 972 1281 999">■ ■</td> <td data-bbox="1281 972 1351 999">■ ■</td> <td data-bbox="1351 972 1403 999">■ ■</td> </tr> <tr> <td data-bbox="475 1014 732 1041">2. Factory Default</td> <td data-bbox="792 1014 862 1041">■ ■</td> <td data-bbox="862 1014 932 1041">■ ■</td> <td data-bbox="932 1014 1002 1041">■ ■</td> <td data-bbox="1002 1014 1071 1041">■ ■</td> <td data-bbox="1071 1014 1141 1041">■ ■</td> <td data-bbox="1141 1014 1211 1041">■ ■</td> <td data-bbox="1211 1014 1281 1041">■ ■</td> <td data-bbox="1281 1014 1351 1041">■ ■</td> <td data-bbox="1351 1014 1403 1041">■ ■</td> </tr> <tr> <td data-bbox="475 1056 732 1083">3. OS Reinstall</td> <td data-bbox="792 1056 862 1083">■ ■</td> <td data-bbox="862 1056 932 1083">■ ■</td> <td data-bbox="932 1056 1002 1083">■ ■</td> <td data-bbox="1002 1056 1071 1083">■ ■</td> <td data-bbox="1071 1056 1141 1083">■ ■</td> <td data-bbox="1141 1056 1211 1083">■ ■</td> <td data-bbox="1211 1056 1281 1083">■ ■</td> <td data-bbox="1281 1056 1351 1083">■ ■</td> <td data-bbox="1351 1056 1403 1083">■ ■</td> </tr> <tr> <td data-bbox="475 1098 732 1125">4. Tech Support</td> <td data-bbox="792 1098 862 1125">■ ■</td> <td data-bbox="862 1098 932 1125">■ ■</td> <td data-bbox="932 1098 1002 1125">■ ■</td> <td data-bbox="1002 1098 1071 1125">■ ■</td> <td data-bbox="1071 1098 1141 1125">■ ■</td> <td data-bbox="1141 1098 1211 1125">■ ■</td> <td data-bbox="1211 1098 1281 1125">■ ■</td> <td data-bbox="1281 1098 1351 1125">■ ■</td> <td data-bbox="1351 1098 1403 1125">■ ■</td> </tr> <tr> <td data-bbox="475 1140 732 1167">5. Skip Volume Check</td> <td data-bbox="792 1140 862 1167">■ ■</td> <td data-bbox="862 1140 932 1167">■ ■</td> <td data-bbox="932 1140 1002 1167">■ ■</td> <td data-bbox="1002 1140 1071 1167">■ ■</td> <td data-bbox="1071 1140 1141 1167">■ ■</td> <td data-bbox="1141 1140 1211 1167">■ ■</td> <td data-bbox="1211 1140 1281 1167">■ ■</td> <td data-bbox="1281 1140 1351 1167">■ ■</td> <td data-bbox="1351 1140 1403 1167">■ ■</td> </tr> <tr> <td data-bbox="475 1182 732 1209">6. Memory Test</td> <td data-bbox="792 1182 862 1209">■ ■</td> <td data-bbox="862 1182 932 1209">■ ■</td> <td data-bbox="932 1182 1002 1209">■ ■</td> <td data-bbox="1002 1182 1071 1209">■ ■</td> <td data-bbox="1071 1182 1141 1209">■ ■</td> <td data-bbox="1141 1182 1211 1209">■ ■</td> <td data-bbox="1211 1182 1281 1209">■ ■</td> <td data-bbox="1281 1182 1351 1209">■ ■</td> <td data-bbox="1351 1182 1403 1209">■ ■</td> </tr> <tr> <td data-bbox="475 1224 732 1251">7. Factory Test</td> <td data-bbox="792 1224 862 1251">■ ■</td> <td data-bbox="862 1224 932 1251">■ ■</td> <td data-bbox="932 1224 1002 1251">■ ■</td> <td data-bbox="1002 1224 1071 1251">■ ■</td> <td data-bbox="1071 1224 1141 1251">■ ■</td> <td data-bbox="1141 1224 1211 1251">■ ■</td> <td data-bbox="1211 1224 1281 1251">■ ■</td> <td data-bbox="1281 1224 1351 1251">■ ■</td> <td data-bbox="1351 1224 1403 1251">■ ■</td> </tr> </tbody> </table>	Boot Menu Sequence	Red Power LED and Red Fan LED Blink Patterns								LED Legend:	■ ■	■ ■	■ ■	■ ■	■ ■	■ ■	■ ■	■ ■	■ ■		Off	Off	On	On	Off	On				Boot Menu Enabled	■ ■	■ ■	■ ■	■ ■	■ ■	■ ■	■ ■	■ ■	■ ■	1. Normal Boot	■ ■	■ ■	■ ■	■ ■	■ ■	■ ■	■ ■	■ ■	■ ■	2. Factory Default	■ ■	■ ■	■ ■	■ ■	■ ■	■ ■	■ ■	■ ■	■ ■	3. OS Reinstall	■ ■	■ ■	■ ■	■ ■	■ ■	■ ■	■ ■	■ ■	■ ■	4. Tech Support	■ ■	■ ■	■ ■	■ ■	■ ■	■ ■	■ ■	■ ■	■ ■	5. Skip Volume Check	■ ■	■ ■	■ ■	■ ■	■ ■	■ ■	■ ■	■ ■	■ ■	6. Memory Test	■ ■	■ ■	■ ■	■ ■	■ ■	■ ■	■ ■	■ ■	■ ■	7. Factory Test	■ ■	■ ■	■ ■	■ ■	■ ■	■ ■	■ ■	■ ■	■ ■
Boot Menu Sequence	Red Power LED and Red Fan LED Blink Patterns																																																																																																													
LED Legend:	■ ■	■ ■	■ ■	■ ■	■ ■	■ ■	■ ■	■ ■	■ ■																																																																																																					
	Off	Off	On	On	Off	On																																																																																																								
Boot Menu Enabled	■ ■	■ ■	■ ■	■ ■	■ ■	■ ■	■ ■	■ ■	■ ■																																																																																																					
1. Normal Boot	■ ■	■ ■	■ ■	■ ■	■ ■	■ ■	■ ■	■ ■	■ ■																																																																																																					
2. Factory Default	■ ■	■ ■	■ ■	■ ■	■ ■	■ ■	■ ■	■ ■	■ ■																																																																																																					
3. OS Reinstall	■ ■	■ ■	■ ■	■ ■	■ ■	■ ■	■ ■	■ ■	■ ■																																																																																																					
4. Tech Support	■ ■	■ ■	■ ■	■ ■	■ ■	■ ■	■ ■	■ ■	■ ■																																																																																																					
5. Skip Volume Check	■ ■	■ ■	■ ■	■ ■	■ ■	■ ■	■ ■	■ ■	■ ■																																																																																																					
6. Memory Test	■ ■	■ ■	■ ■	■ ■	■ ■	■ ■	■ ■	■ ■	■ ■																																																																																																					
7. Factory Test	■ ■	■ ■	■ ■	■ ■	■ ■	■ ■	■ ■	■ ■	■ ■																																																																																																					

- 1. Boot Menu Enabled:** Use the **Reset** button to scroll through the menu to select an option within 3 seconds. After 3 seconds the boot menu defaults to Normal Boot.
- 2. Normal Boot:** Perform a normal boot.
- 3. Factory Default:** Reset the ReadyNAS back to its Factory Default state, erasing all data on the disks. This option can be used to change between X-RAID2 and Flex-RAID mode.



**WARNING!**

This process reinstalls the firmware and resets all disk configurations, **wiping out any data** you might have on the unit.

- 4. OS Reinstall:** While keeping the data volume in tact, re-install the RAIDiator firmware on the ReadyNAS, reset the admin password, and change the DHCP assignment to DHCP client. This is helpful if you have lost your admin password and want to set it back to the default, if errors in your network settings have made it impossible to connect to the ReadyNAS, or if you suspect that the operating system on your disk may somehow be corrupt.

**Tip:** If possible, backup your configuration so that if you have to reset the unit to its factory default settings, you can simply restore all your settings from the configuration backup. For instructions on how to back up your configuration, see the *ReadyNAS for Business Software Manual*.

- 5. Tech Support:** Enable the remote diagnostic function.
- 6. Skip Volume Check:** Boot the system but bypass the volume check.
- 7. Memory Test:** Performs a memory diagnostic.

## Reinstall Firmware using OS Reinstall Option

To reinstall the RAIDar firmware on the ReadyNAS without touching the data volume, follow these steps.

1. While using a paper clip or push pin to gently press in the **Reset** button, power on the unit. Wait for the two red boot menu status lights on the front to display, then release the **Reset** button.

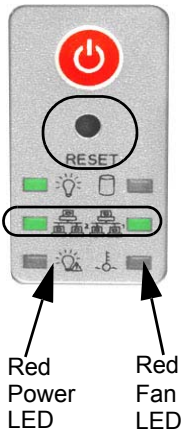
Control Panel	Boot Menu Options							
	<b>Boot Menu Sequence</b>		<b>Red Power LED and Red Fan LED Blink Patterns</b>					
	LED Legend:		■ ■ Off Off	■ ■ On On	■ ■ Off On			
	Boot Menu Enabled		■ ■					
	1. Normal Boot		■ ■	■ ■				
	2. Factory Default							
	3. OS Reinstall		■ ■	■ ■	■ ■	■ ■		
	4. Tech Support							
	5. Skip Volume Check							
6. Memory Test								
7. Factory Test								

2. Push the Reset button on the front panel three times to select the **OS Reinstall** option.



### WARNING!

**If you mistakenly select the Factory Default option, all data on the unit will be deleted. If you are unsure, let the system boot normally, before attempting this procedure again.**

The system does the following:

- a. Displays the OS Reinstall blink pattern.
  - b. Holds the final LED displays (off on), and waits for you to confirm the selection.
3. Press the and hold the reset button for 3 seconds to confirm the menu selection and proceed with that option. The system does the following:
    - a. Blinks both LEDs twice to confirm the selection.
    - b. Proceeds with reinstalling the firmware.
    - c. Reboots when the firmware reinstall is complete.

The data will be in tact. The user name, password, and system configuration settings will be the factory default values.

## Using the Boot Menu to Format a RAID Volume



**WARNING!**

Using the Factory Default boot menu option will erase all the data on the hard disks. Do a full backup before using the Factory Default option.

The ReadyNAS comes preconfigured in Expandable Volume (X-RAID2) mode. You can switch between X-RAID2 and the Flexible Volume mode (Flex-RAID) if you want to manually configure standard RAID (ie., RAID levels 0, 1, 5, or 6). For a brief overview of X-RAID2 and Flex-RAID, see the *ReadyNAS for Business Software Manual*.

**To reconfigure your RAID setup:**

1. Power off the ReadyNAS.
2. Use a paper clip or push pin to gently press in the **Reset** button, power on the unit, wait for the boot menu on the front to display, then release the **Reset** button.

Control Panel	Boot Menu Options							
	Boot Menu Sequence		Red Power LED and Red Fan LED Blink Patterns					
	LED Legend:		■ ■ Off Off	■ ■ On On	■ ■ Off On			
	Boot Menu Enabled		■ ■					
	1. Normal Boot		■ ■	■ ■				
	2. Factory Default		■ ■	■ ■				
	3. OS Reinstall							
4. Tech Support								
5. Skip Volume Check								

3. Push the **Reset** button on the front panel two times to select the **Factory Default** option.

The system does the following:

- a. Displays the Factory Default blink pattern.
- b. Holds the display of the final LEDs in the pattern (on on), and waits for you to confirm the selection.

4. Press and hold the **Reset** button for 3 seconds to confirm the menu selection and proceed with that option.

The system does the following:

- a. Blinks both LEDs twice to confirm the selection.
- b. Proceeds with clearing the disks.
- c. Powers down.

5. Power on the system.

The system does the following:

- a. Reboots.
- b. Performs disk diagnostics.

The disks now need to be formatted.

6. Run the RAIDar utility. RAIDar prompts you to click **Setup**

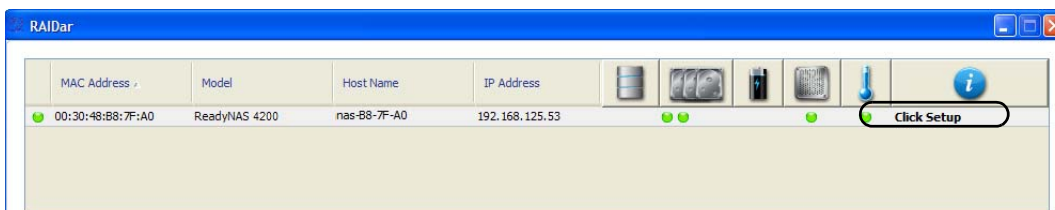

7. Click **Setup** to display the ReadyNAS Volume Setup screen.

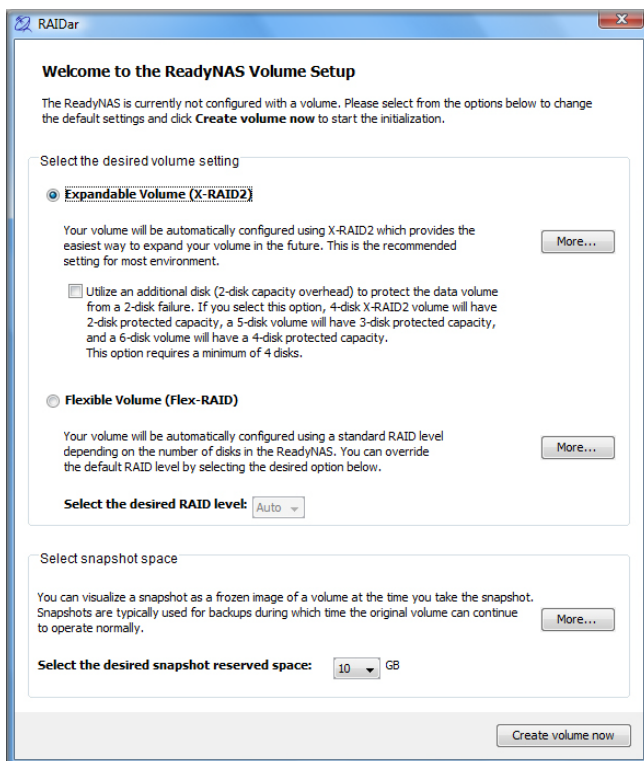

8. Select either the **Expandable Volume (X-RAID2)** or the **Flexible Volume (Flex-RAID)** radio button, configure the options accordingly, and click **Create volume now**. The volume and initialization process begins.

---

**Note:** If no action is taken within 10 minutes, the system defaults to X-RAID2 with 10 GB reserved for snapshots.

---

RAIDar shows that the system is initializing the volume. The system powers down when the volume initialization is complete.



9. Power the system on. It performs diagnostics while it boots.
10. Click **Rescan** in RAIDar to connect to the system.

RAIDar finds the system and show that it is booting.



11. When RAIDar shows that the system is ready, select the system from the list, and click **Setup** to log in to FrontView and configure the system.

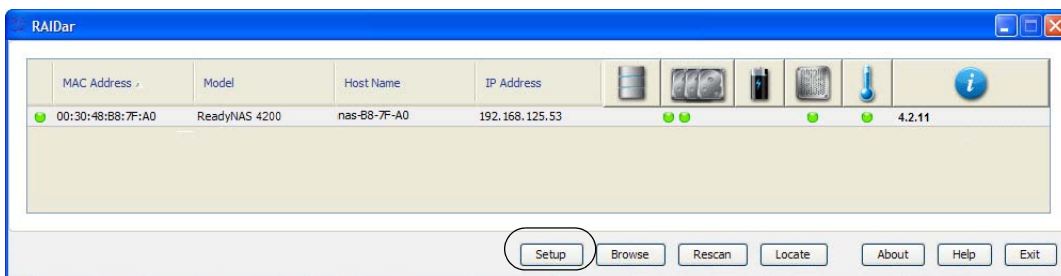



## Adding or Replacing Disks

Adding and replacing failed disks are similar processes.

---

**Note:** Be sure to check the Hardware Compatibility list on the NETGEAR Support site for a list of disks that have been qualified for the ReadyNAS 4200 to assure that you use a suitable disk.

---

In the case of a failed disk, the unit gives email alerts and status messages about the need to replace the disk.



### WARNING!

Regardless of how many hard drives are installed, all drive trays must remain in the drive bays to maintain proper airflow.

## Adding a New Disk

### To add a new disk:

1. Pull the disk tray release pull switch. The tray handle pops out.



2. Pull out the disk tray, and replace the failed disk.

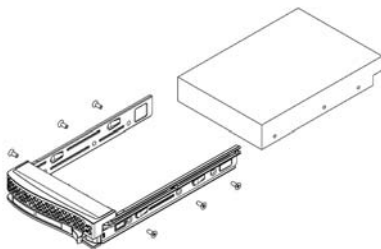

Make sure that the hard disk connectors face the interior of the disk bay when you reassemble the disk.

3. Slide the disk tray back into the ReadyNAS and secure the handle.

The volume automatically synchronizes with the new disk in the background, taking several hours depending on the disk size. The ReadyNAS can continue to be used, although access will be slower until the volume synchronization finishes. You are notified by e-mail when the process is complete.

## Failed Disk Notification

When a disk fails in your ReadyNAS, you are notified of the failure by e-mail. The FrontView **Health** screen provides information about the failed disk. The disk tray of the ReadyNAS 4200 includes a failed disk LED that turns amber when its disk fails.

Device	Description	Status
● Disk 1	Seagate ST3500312CS 465 GB , 26 C / 78 F , Write-cache ON	SMART+ OK
● Disk 2	Seagate ST3500312CS 465 GB , 28 C / 82 F , Write-cache ON	SMART+ FAIL
● Fan SYS	1849 RPM	Recalibrate OK
● Fan SYS2	4821 RPM	Recalibrate OK
● Fan CPU	2860 RPM	OK
● Fan SYS1	4963 RPM	OK
● Fan SYS3	4821 RPM	OK
● Power Supply 1		OK
● Power Supply 2		OK
● Temp 1	26 C / 78 F [Normal 0-60 C / 32-140 F]	OK
● Temp 2	35 C / 95 F [Normal 0-60 C / 32-140 F]	OK
● UPS 1	Not present	NA

## Choosing a Replacement Disk

On the FrontView main menu, select Status > Health. Take note of the disk vendor and model used in your ReadyNAS. It is best to replace a failed disk with the same disk model. Contact the disk vendor, and arrange to have the disk replaced if the disk is still under warranty. A disk RMA from the vendor requires that you provide the serial number of the disk. To locate the serial number, open the disk tray and take out the failed disk.

## Replacing a Failed Disk

ReadyNAS supports hot-swap bays, so there is no need to power it down when a disk fails.

### To replace the failed disk:

1. View the disk tray failed disk LED to identify which disk has failed.
2. Pull the disk tray release pull switch. The disk tray handle pops out.



3. Pull out the disk tray, and replace the failed disk.

Make sure that the hard disk connectors face the interior of the disk bay when you reassemble the disk.

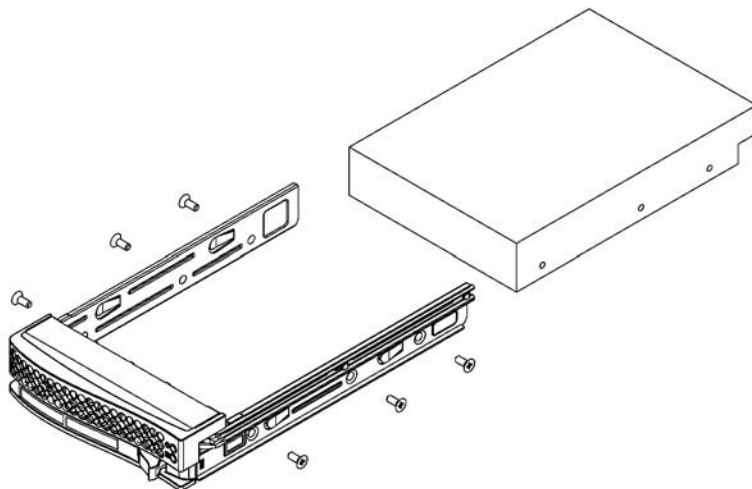

4. Slide the disk tray back into the ReadyNAS and secure the handle.

The volume automatically synchronizes with the new disk in the background. The process takes several hours depending on the disk size. During this process, the ReadyNAS can be used, although access will be slower until the volume finishes synchronizing. You are notified by e-mail when the process is complete.

## Replacing System Components

You can replace failed components such as power supplies, fans, and the system battery. This section explains how to replace failed components.

You might need to access the inside of the system to replace failed components.

### To access the inside of the system

1. Grasp the two handles on either side and pull the unit straight out until it locks; you will hear a “click”.
2. Press the two buttons on the top of the chassis to release the top cover.

You can then lift the top cover from the chassis to gain full access to the inside of the system

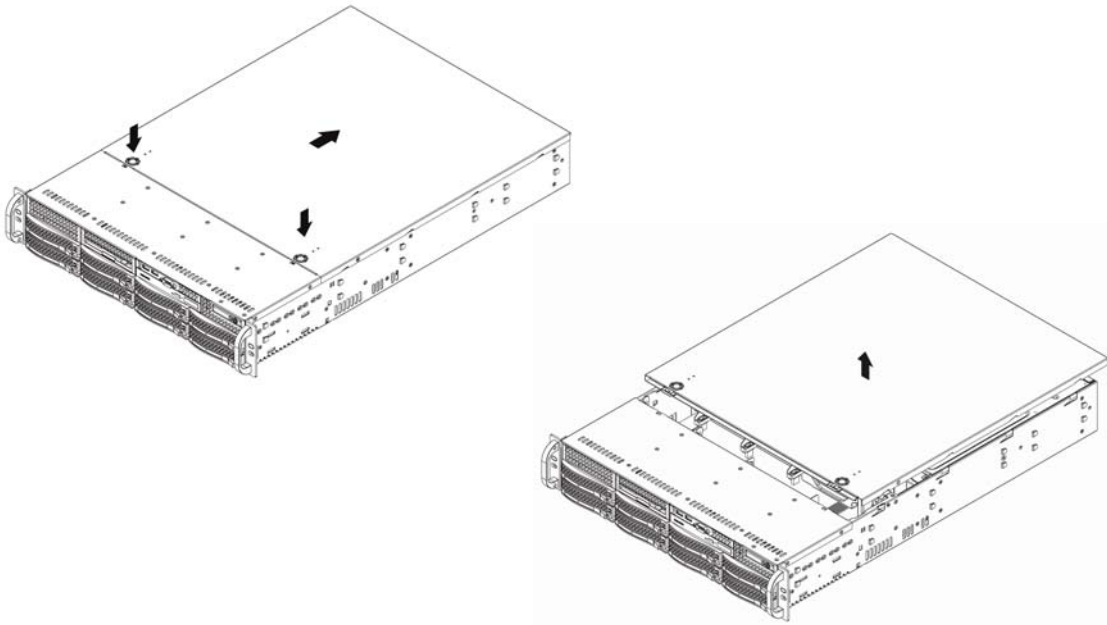

### WARNING!

Care must be taken to assure that the chassis cover is in place when the system is operating to ensure proper cooling. Out-of-warranty damage to the system can occur if this practice is not strictly followed.

## Replacing a System Fan

Fan speed is controlled by system temperature, as monitored by the RAIDiator firmware. If a fan fails, the remaining fans ramp up to full speed, the overheat/fan fail LED on the control panel turns on, and an email alert are sent to the system administrator. Replace any failed fan at your earliest convenience. Remove the top chassis cover while the system is still running to determine which of the fans has failed.

Follow these steps to replace a system fan.



---

**Note:** System power does not need to be shut down since the fans are hot-pluggable.

---

1. Remove the chassis cover.
2. Press the tabs on the sides of the fan to unlock and remove the fan and its housing. The fan's power connection automatically detaches.
3. Replace the failed fan with an identical fan. See "[Technical Specifications](#)" in Appendix A for fan specifications.

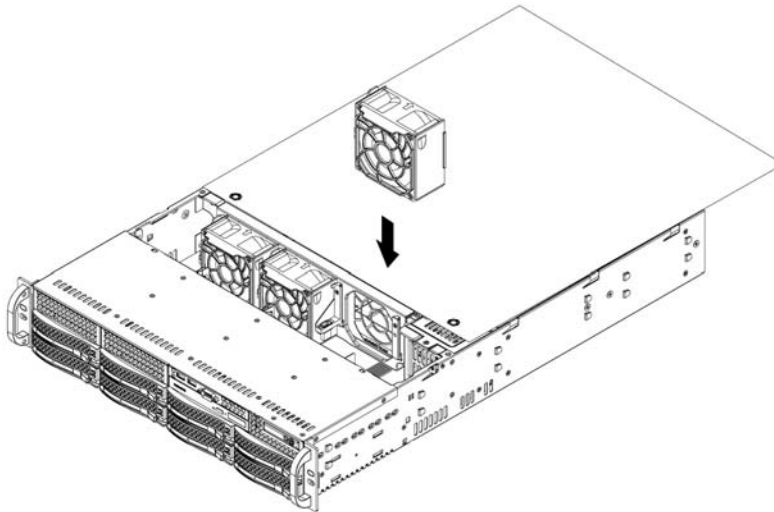

A “click” can be heard when the fan is fully installed in place and the power connections are made. If the system power is on, the hot-plug feature causes the fan to start immediately upon being connected to its header on the mainboard.

## Replacing a Power Supply

The ReadyNAS 4200 has a 700 watt redundant power supply consisting of two power modules. Each power supply module has an auto-switching capability, which enables it to automatically sense and operate at a 100V - 240V input voltage.

If either of the two power supply modules fails, the other module takes the full load and allows the system to continue operation without interruption. The **PWR Fail** LED illuminates and remains on until the failed unit has been replaced. The power supply units have a hot-swap capability, meaning you can replace the failed unit without powering down the system.

You do not need to shut down the system to replace a power supply unit. The backup power supply module keeps the system up and running while you replace the failed hot-swap unit. Replace the failed power supply with the same model.

1. Unplug the AC power cord from the failed power supply module.
2. Depress the locking tab on the power supply module. Use the handle to pull it straight out with the rounded handle.
3. Install a new power supply. Push the new power supply unit into the power bay until you hear a click. Secure the locking tab on the unit.
4. Plug the AC power cord back into the unit.

## Replacing the Onboard Battery

This battery must be replaced only with the same or an equivalent type recommended by NETGEAR. Dispose of used batteries according to the manufacturer's instructions.



### DANGER:

There is a danger of explosion if the onboard battery is installed upside down, which will reverse its polarities.

To replace the battery, open the system, locate the battery holder, and replace the battery, taking care to install the new one with the correct side up.

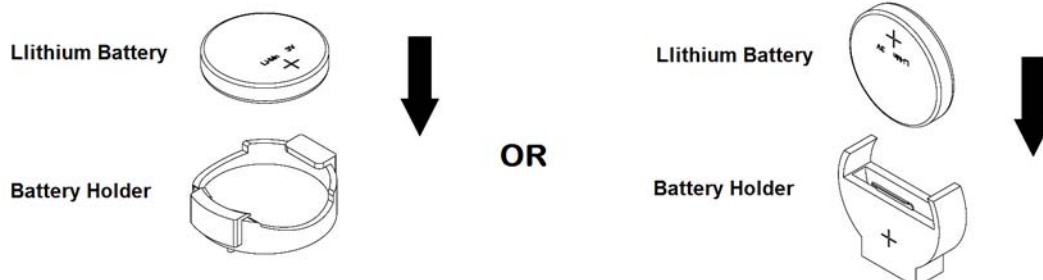

# Default Settings and Specifications

---



This appendix provides the factory default settings and system specifications.

- [Factory Default Settings](#)
- [Technical Specifications](#)

## Factory Default Settings

To return the ReadyNAS to its factory default configuration settings shown below, see [“Reinstall Firmware using OS Reinstall Option”](#) on page 21.

Feature	Default
<b>Login</b>	
User login URL when the ReadyNAS 4200 is not connected to a DHCP server	https://192.168.168.168/admin
Admin user name (case-sensitive)	admin
Admin login password (case-sensitive)	netgear1
<b>Management</b>	
System configuration	FrontView web-based configuration and status monitoring
Discovery, multi-unit status monitoring, and RAID formatting utility	RAIDar for Windows, Mac, and Linux
<b>LAN Connections</b>	
MAC address	Default address
MTU size	1500
Ports	2 Auto Sense 10/100/1000BASE-T, RJ-45
LAN IP address	DHCP acquired



## Technical Specifications

The table below lists the system specifications.

Feature		Specification
<b>Electrical</b>		
	Power supplies (PSU)	Two 700W server rated AC power supplies
	Input	100-240V AC, 50/60Hz
	Power consumption	170W typical with 6 1TB disks
<b>Thermal</b>		
	Cooling Fans	Three 80 mm dual ball-bearing chassis cooling fans
	Fan failure alerts	Hardware LED, software via FrontView and high temperature email alert with auto-shutdown option.
<b>Operating Environmental</b>		
	Temperature	0° - 40° C (32° - 104° F)
	Humidity (non-condensing)	20% - 80%
<b>Physical</b>		
	Form factor	2U rack-mount with 12 hot swappable SATA drive bays
	Dimensions (H x W x D)	3.5 x 17.2 x 25.5 in. (89 x 437 x 648 mm)
	Weight	32.8 kg (76 lb) with 12 disks
<b>Optional Spare Parts</b>		
	Disk tray	Hot-swappable SATA drive tray
	Cooling fan	80 mm dual ball-bearing chassis cooling fan
	PSU	Hot-swappable 700W PSU
	Rack mount	Sliding rails

# Notification of Compliance

---



## **Certificate of the Manufacturer/Importer**

It is hereby certified that the TBD has been suppressed in accordance with the conditions set out in the BMPT-AmtsblVfg 243/1991 and Vfg 46/1992. The operation of some equipment (for example, test transmitters) in accordance with the regulations may, however, be subject to certain restrictions. Please refer to the notes in the operating instructions.

The Federal Office for Telecommunications Approvals has been notified of the placing of this equipment on the market and has been granted the right to test the series for compliance with the regulations.

## **Bestätigung des Herstellers/Importeurs**

Es wird hiermit bestätigt, daß dasTBD gemäß der im BMPT-AmtsblVfg 243/1991 und Vfg 46/1992 aufgeführten Bestimmungen entstört ist. Das vorschriftsmäßige Betreiben einiger Geräte (z.B. Testsender) kann jedoch gewissen Beschränkungen unterliegen. Lesen Sie dazu bitte die Anmerkungen in der Betriebsanleitung.

Das Bundesamt für Zulassungen in der Telekommunikation wurde davon unterrichtet, daß dieses Gerät auf den Markt gebracht wurde und es ist berechtigt, die Serie auf die Erfüllung der Vorschriften hin zu überprüfen.

## **Voluntary Control Council for Interference (VCCI) Statement**

This equipment is in the Class B category (information equipment to be used in a residential area or an adjacent area thereto) and conforms to the standards set by the Voluntary Control Council for Interference by Data Processing Equipment and Electronic Office Machines aimed at preventing radio interference in such residential areas. When used near a radio or TV receiver, it may become the cause of radio interference. Read instructions for correct handling.

## **FCC Caution**

- Any changes or modifications not expressly approved by the party responsible for compliance could void the user's authority to operate this equipment.
- This device complies with Part 15 of the FCC Rules. Operation is subject to the following two conditions: (1) This device may not cause harmful interference, and (2) this device must accept any interference received, including interference that may cause undesired operation.

## **Regulatory Compliance Information**

This section includes user requirements for operating this product in accordance with National laws for usage of radio spectrum and operation of radio devices. Failure of the end-user to comply with the applicable requirements may result in unlawful operation and adverse action against the end-user by the applicable National regulatory authority.

**Note: This product's firmware limits operation to only the channels allowed in a particular Region or Country. Therefore, all options described in this user's guide may not be available in your version of the product.**

## Europe – EU Declaration of Conformity



Marking by the above symbol indicates compliance with the Essential Requirements of the R&TTE Directive of the European Union (1999/5/EC). This equipment meets the following conformance standards:

EN300 328, EN301 489-17, EN60950

For complete DoC please visit the NETGEAR EU Declarations of Conformity website at:

[http://kb.netgear.com/app/answers/detail/a\\_id/11621/](http://kb.netgear.com/app/answers/detail/a_id/11621/)

### EDOC in Languages of the European Community

Cesky [Czech]	<i>NETGEAR Inc.</i> tímto prohlašuje, že tento Radiolan je ve shode se základními požadavky a dalšími příslušnými ustanoveními směrnice 1999/5/ES.
Dansk [Danish]	Undertegnede <i>NETGEAR Inc.</i> erklærer herved, at følgende udstyr Radiolan overholder de væsentlige krav og øvrige relevante krav i direktiv 1999/5/EF.
Deutsch [German]	Hiermit erkläre <i>NETGEAR Inc.</i> , dass sich das Gerät Radiolan in Übereinstimmung mit den grundlegenden Anforderungen und den übrigen einschlägigen Bestimmungen der Richtlinie 1999/5/EG befindet.
Eesti [Estonian]	Käesolevaga kinnitab <i>NETGEAR Inc.</i> seadme Radiolan vastavust direktiivi 1999/5/EÜ põhinõuetele ja nimetatud direktiivist tulenevatele teistele asjakohastele sätetele.
English	Hereby, <i>NETGEAR Inc.</i> , declares that this Radiolan is in compliance with the essential requirements and other relevant provisions of Directive 1999/5/EC.
Español [Spanish]	Por medio de la presente <i>NETGEAR Inc.</i> declara que el Radiolan cumple con los requisitos esenciales y cualesquiera otras disposiciones aplicables o exigibles de la Directiva 1999/5/CE.
Ελληνική [Greek]	ΜΕ ΤΗΝ ΠΑΡΟΥΣΑ <i>NETGEAR Inc.</i> ΔΗΛΩΝΕΙ ΟΤΙ Radiolan ΣΥΜΜΟΡΦΩΝΕΤΑΙ ΠΡΟΣ ΤΙΣ ΟΥΣΙΩΔΕΙΣ ΑΠΑΙΤΗΣΕΙΣ ΚΑΙ ΤΙΣ ΛΟΙΠΕΣ ΣΧΕΤΙΚΕΣ ΔΙΑΤΑΞΕΙΣ ΤΗΣ ΟΔΗΓΙΑΣ 1999/5/ΕΚ.
Français [French]	Par la présente <i>NETGEAR Inc.</i> déclare que l'appareil Radiolan est conforme aux exigences essentielles et aux autres dispositions pertinentes de la directive 1999/5/CE.
Italiano [Italian]	Con la presente <i>NETGEAR Inc.</i> dichiara che questo Radiolan è conforme ai requisiti essenziali ed alle altre disposizioni pertinenti stabilite dalla direttiva 1999/5/CE.
Latviski [Latvian]	Ar šo <i>NETGEAR Inc.</i> deklarē, ka Radiolan atbilst Direktīvas 1999/5/EK būtiskajām prasībām un citiem ar to saistītajiem noteikumiem.
Lietuvių [Lithuanian]	Šiuo <i>NETGEAR Inc.</i> deklaruoja, kad šis Radiolan atitinka esminius reikalavimus ir kitas 1999/5/EB Direktyvos nuostatas.
Nederlands [Dutch]	Hierbij verklaart <i>NETGEAR Inc.</i> dat het toestel Radiolan in overeenstemming is met de essentiële eisen en de andere relevante bepalingen van richtlijn 1999/5/EG.

## EDOC in Languages of the European Community

Malti [Maltese]	Hawnhekk, <i>NETGEAR Inc.</i> , jiddikjara li dan Radiolan jikkonforma mal-htigijiet essenzjali u ma provvedimenti oħrajn relevanti li hemm fid-Dirrettiva 1999/5/EC.
Magyar [Hungarian]	Alulírott, <i>NETGEAR Inc.</i> nyilatkozom, hogy a Radiolan megfelel a vonatkozó alapvető követelményeknek és az 1999/5/EC irányelv egyéb előírásainak.
Polski [Polish]	Niniejszym <i>NETGEAR Inc.</i> oświadcza, że Radiolan jest zgodny z zasadniczymi wymogami oraz pozostałymi stosownymi postanowieniami Dyrektywy 1999/5/EC.
Português [Portuguese]	<i>NETGEAR Inc.</i> declara que este Radiolan está conforme com os requisitos essenciais e outras disposições da Directiva 1999/5/CE.
Slovensko [Slovenian]	<i>NETGEAR Inc.</i> izjavlja, da je ta Radiolan v skladu z bistvenimi zahtevami in ostalimi relevantnimi določili direktive 1999/5/ES.
Slovensky [Slovak]	<i>NETGEAR Inc.</i> týmto vyhlasuje, že Radiolan spĺňa základné požiadavky a všetky príslušné ustanovenia Smernice 1999/5/ES.
Suomi [Finnish]	<i>NETGEAR Inc.</i> vakuuttaa täten että Radiolan tyyppinen laite on direktiivin 1999/5/EY oleellisten vaatimusten ja sitä koskevien direktiivin muiden ehtojen mukainen.
Svenska [Swedish]	Härmed intygar <i>NETGEAR Inc.</i> att denna Radiolan står i överensstämmelse med de väsentliga egenskapskrav och övriga relevanta bestämmelser som framgår av direktiv 1999/5/EG.
Íslenska [Icelandic]	Hér með lýsir <i>NETGEAR Inc.</i> yfir því að Radiolan er í samræmi við grunnkröfur og aðrar kröfur, sem gerðar eru í tilskipun 1999/5/EC.
Norsk [Norwegian]	<i>NETGEAR Inc.</i> erklærer herved at utstyret <i>Radiolan</i> er i samsvar med de grunnleggende krav og øvrige relevante krav i direktiv 1999/5/EF.

## FCC Requirements for Operation in the United States

### FCC Information to User

This product does not contain any user serviceable components and is to be used with approved antennas only. Any product changes or modifications will invalidate all applicable regulatory certifications and approvals.

### FCC Guidelines for Human Exposure

This equipment complies with FCC radiation exposure limits set forth for an uncontrolled environment. This equipment should be installed and operated with minimum distance of 20 cm between the radiator and your body. This transmitter must not be co-located or operating in conjunction with any other antenna or transmitter.

### FCC Declaration Of Conformity

We, NETGEAR, Inc., 350 East Plumeria Drive, Santa Clara, CA 95134, declare under our sole responsibility that the model MS2110 TBD complies with Part 15 of FCC Rules. Operation is subject to the following two conditions:

- This device may not cause harmful interference, and
- This device must accept any interference received, including interference that may cause undesired operation.

### FCC Radio Frequency Interference Warnings & Instructions

This equipment has been tested and found to comply with the limits for a Class B digital device, pursuant to Part 15 of the FCC Rules. These limits are designed to provide reasonable protection against harmful interference in a residential installation. This equipment uses and can radiate radio frequency energy and, if not installed and used in accordance with the instructions, may cause harmful interference to radio communications. However, there is no guarantee that interference will not occur in a particular installation. If this equipment does cause harmful interference to radio or television reception, which can be determined by turning the equipment off and on, the user is encouraged to try to correct the interference by one or more of the following methods:

- Reorient or relocate the receiving antenna.
- Increase the separation between the equipment and the receiver.
- Connect the equipment into an electrical outlet on a circuit different from that which the radio receiver is connected.
- Consult the dealer or an experienced radio/TV technician for help.

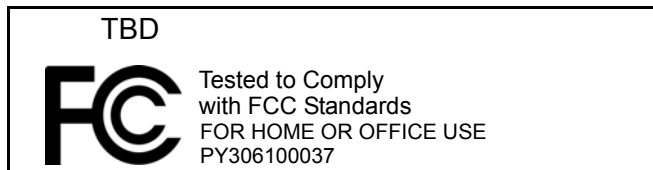

Modifications made to the product, unless expressly approved by NETGEAR, Inc., could void the user's right to operate the equipment.

### Canadian Department of Communications Radio Interference Regulations

This digital apparatus (TBD) does not exceed the Class B limits for radio-noise emissions from digital apparatus as set out in the Radio Interference Regulations of the Canadian Department of Communications.

Canada ID: 4054A-FVX538

# Index

## A

activity light **6**  
airflow **8**

## B

battery **12**  
    replace **12**  
battery, replace **30**  
boot menu **19**

## C

changing between X-RAID and Flex-RAID **19**  
circuit overload **8**  
compliance **34**  
components **28**  
control panel **6, 16**

## D

default IP **11**  
diagnostics **15, 19**  
disk bays **6**  
disk failure **26**  
disk weight **8**  
disks, add **25**  
disks, failure **26**  
disks, replace **25, 27**

## E

electrical safety **12**  
electrostatic discharge **14**  
ESD **14**

## F

factory default **19**  
failed disk  
    ordering replacement disks **26**  
    replacing, how to **26**  
failure light **6**

fan, replace **29**  
firmware **21**  
front panel **6**  
FrontView **18**

## G

general safety **13**  
grounding **8**

## M

mechanical loading **8**

## N

netgear1 **11**

## O

operating temperature **8**

## P

ports **6**  
power **18**  
power supply, replace **30**  
power switch **18**

## R

rack mount **8, 14**  
RAID  
    setup, reconfiguring **22**  
RAID volume, format **22**  
RAID, reconfigure **22**  
rear panel **7**  
reconfigure RAID **22**  
reinstall firmware **21**  
replace **28**  
replacement disks  
    ordering **26**  
reset **6**  
resynchronizing volume **25, 27**

## S

safety [12](#), [13](#)  
setup location [9](#)  
Shutdown [24](#)  
socket-outlet [12](#)  
status display [6](#)  
system specifications [33](#)

## T

technical specifications [33](#)  
tray handle [6](#)

## W

weight [8](#)