



# ReadyNAS OS 6 Desktop Storage Systems

## Hardware Manual

### Model

ReadyNAS 102, 104

ReadyNAS 202, 204, 212, 214

ReadyNAS 312, 314, 316

ReadyNAS 422, 424, 426, 428

ReadyNAS 516, 524X, 526X, 528X

ReadyNAS 626X, 628X

ReadyNAS 716X

EDA 500

April 2017  
202-11206-10

350 E. Plumeria Drive  
San Jose, CA 95134  
USA

### Support

Thank you for purchasing this NETGEAR product. You can visit [www.netgear.com/support](http://www.netgear.com/support) to register your product, get help, access the latest downloads and user manuals, and join our community. We recommend that you use only official NETGEAR support resources.

### Conformity

For the current EU Declaration of Conformity, visit [http://kb.netgear.com/app/answers/detail/a\\_id/11621](http://kb.netgear.com/app/answers/detail/a_id/11621).

### Compliance

For regulatory compliance information, visit <http://www.netgear.com/about/regulatory>.

See the regulatory compliance document before connecting the power supply.

### Trademarks

© NETGEAR, Inc., NETGEAR, and the NETGEAR Logo are trademarks of NETGEAR, Inc. Any non-NETGEAR trademarks are used for reference purposes only.

# Contents

## Chapter 1 Getting Started

Additional Documentation.....	13
Setup Locationsetup location.....	13
Supported Operating Systems.....	13
Supported Browsers.....	14
Diskless Storage Systems.....	14

## Chapter 2 NETGEAR ReadyNAS 102

Front and Side Panels.....	16
Drive Bays.....	16
Rear Panel.....	17
Status Information.....	18
Power On and Shut Down.....	19
Power On.....	20
Preferred Shutdown.....	20
Forced Shutdown.....	20
Boot Menu.....	20

## Chapter 3 NETGEAR ReadyNAS 104

Front and Side Panels.....	24
Drive Bays.....	24
Rear Panel.....	25
Status Information.....	26
Power On and Shut Down.....	27
Power On.....	28
Preferred Shutdown.....	28
Forced Shutdown.....	28
Boot Menu.....	28

## Chapter 4 NETGEAR ReadyNAS 202

Front and Side Panels.....	31
Drive Bays.....	31
Rear Panel.....	32
Status Information.....	33
Power On and Shut Down.....	34
Power On.....	35
Preferred Shutdown.....	35
Forced Shutdown.....	35
Boot Menu.....	35

## Chapter 5 NETGEAR ReadyNAS 204

Front and Side Panels.....	39
----------------------------	----

## ReadyNAS OS 6 Desktop Storage Systems

Drive Bays.....	39
Rear Panel.....	40
Status Information.....	41
Power On and Shut Down.....	42
Power On.....	43
Preferred Shutdown.....	43
Forced Shutdown.....	43
Boot Menu.....	43

### Chapter 6 NETGEAR ReadyNAS 212

Front and Side Panels.....	46
Drive Bays.....	46
Rear Panel.....	47
Status Information.....	48
Power On and Shut Down.....	49
Power On.....	50
Preferred Shutdown.....	50
Forced Shutdown.....	50
Boot Menu.....	50

### Chapter 7 NETGEAR ReadyNAS 214

Front and Side Panels.....	54
Drive Bays.....	54
Rear Panel.....	55
Status Information.....	56
Power On and Shut Down.....	57
Power On.....	58
Preferred Shutdown.....	58
Forced Shutdown.....	58
Boot Menu.....	58

### Chapter 8 NETGEAR ReadyNAS 312

Front and Side Panels.....	61
Drive Bays.....	61
Rear Panel.....	62
Status Information.....	63
Power On and Shut Down.....	64
Power On.....	64
Preferred Shutdown.....	65
Forced Shutdown.....	65
Boot Menu.....	65

### Chapter 9 NETGEAR ReadyNAS 314

Front and Side Panels.....	69
Drive Bays.....	69
Rear Panel.....	70
Status Information.....	71
Power On and Shut Down.....	72

## ReadyNAS OS 6 Desktop Storage Systems

Power On.....	73
Preferred Shutdown.....	73
Forced Shutdown.....	73
Boot Menu.....	74

### Chapter 10 NETGEAR ReadyNAS 316

Front and Side Panels.....	77
Drive Bays.....	77
Rear Panel.....	78
Status Information.....	79
Power On and Shut Down.....	80
Power On.....	80
Preferred Shutdown.....	81
Forced Shutdown.....	81
Boot Menu.....	81

### Chapter 11 NETGEAR ReadyNAS 422

Front and Side Panels.....	84
Drive Bays.....	85
Rear Panel.....	86
Status Information.....	87
Power On and Shut Down.....	87
Power On.....	88
Preferred Shutdown.....	88
Forced Shutdown.....	88
Boot Menu.....	89

### Chapter 12 NETGEAR ReadyNAS 424

Front and Side Panels.....	92
Drive Bays.....	93
Rear Panel.....	94
Status Information.....	95
Power On and Shut Down.....	95
Power On.....	96
Preferred Shutdown.....	96
Forced Shutdown.....	96
Boot Menu.....	97

### Chapter 13 NETGEAR ReadyNAS 426

Front and Side Panels.....	100
Drive Bays.....	101
Rear Panel.....	102
Status Information.....	103
Power On and Shut Down.....	103
Power On.....	104
Preferred Shutdown.....	104
Forced Shutdown.....	105
Boot Menu.....	105

**Chapter 14 NETGEAR ReadyNAS 428**

Front and Side Panels.....108  
Drive Bays.....109  
Rear Panel.....110  
Status Information.....111  
Power On and Shut Down.....111  
    Power On.....112  
    Preferred Shutdown.....112  
    Forced Shutdown.....112  
Boot Menu.....113

**Chapter 15 NETGEAR ReadyNAS 516**

Front and Side Panels.....116  
Drive Bays.....116  
Rear Panel.....117  
Status Information.....118  
Power On and Shut Down.....119  
    Power On.....119  
    Preferred Shutdown.....120  
    Forced Shutdown.....120  
Boot Menu.....120

**Chapter 16 NETGEAR ReadyNAS 524X**

Front and Side Panels.....123  
Drive Bays.....124  
Rear Panel.....125  
Status Information.....126  
Power On and Shut Down.....127  
    Power On.....127  
    Preferred Shutdown.....128  
    Forced Shutdown.....128  
Boot Menu.....128

**Chapter 17 NETGEAR ReadyNAS 526X and 626X**

Front and Side Panels.....131  
Drive Bays.....132  
Rear Panel ReadyNAS 526X.....133  
Rear Panel ReadyNAS 626X.....134  
Status Information.....135  
Power On and Shut Down.....136  
    Power On.....136  
    Preferred Shutdown.....137  
    Forced Shutdown.....137  
Boot Menu.....137

**Chapter 18 NETGEAR ReadyNAS 528X and 628X**

Front and Side Panels.....140

## ReadyNAS OS 6 Desktop Storage Systems

Drive Bays.....	141
Rear Panel ReadyNAS 528X.....	142
Rear Panel ReadyNAS 628X.....	143
Status Information.....	144
Power On and Shut Down.....	145
Power On.....	145
Preferred Shutdown.....	146
Forced Shutdown.....	146
Boot Menu.....	146

### Chapter 19 NETGEAR ReadyNAS 716X

Front and Side Panels.....	149
Drive Bays.....	149
Rear Panel.....	150
Status Information.....	151
Power On and Shut Down.....	153
Power On.....	153
Preferred Shutdown.....	154
Forced Shutdown.....	154
Boot Menu.....	154

### Chapter 20 NETGEAR EDA 500

Front and Side Panels.....	157
Drive Bays.....	157
Rear Panel.....	158
Status Information.....	159
Power On and Shut Down.....	160
Power On.....	160
Preferred Shutdown.....	161
Forced Shutdown.....	161

### Chapter 21 Disks

Disk Trays.....	163
Standard Disk Traydisk trays standard.....	163
EDA 500 Disk Tray.....	164
Supported Disks.....	164
Previously Formatted Disks.....	165
Reformat Previously Formatted Disks.....	165
Migrate a Volume.....	166
Add a Disk.....	166
Add a 3.5-Inch Disk.....	166
Add a 2.5-Inch Disk.....	171
Replace a Disk.....	175
Replace a 3.5-Inch Disk.....	175
Replace a 2.5-Inch Disk.....	180

### Appendix A Defaults and Technical Specifications

Factory Default Settings.....	184
-------------------------------	-----

## ReadyNAS OS 6 Desktop Storage Systems

ReadyNAS 102 Technical Specifications.....	184
General:.....	184
Physical dimensions (h x w x d):.....	185
Physical weight:.....	185
Power consumption:.....	185
Electrical:.....	185
Environmental requirements:.....	185
Certifications:.....	185
ReadyNAS 104 Technical Specifications.....	186
General:.....	186
Physical dimensions (h x w x d):.....	186
Physical weight:.....	186
Power consumption:.....	186
Electrical:.....	186
Environmental requirements:.....	187
Certifications:.....	187
ReadyNAS 202 Technical Specifications.....	187
General:.....	187
Physical dimensions (h x w x d):.....	187
Physical weight:.....	187
Power consumption:.....	188
Electrical:.....	188
Environmental requirements:.....	188
Certifications:.....	188
ReadyNAS 212 Technical Specifications.....	188
General:.....	188
Physical dimensions (h x w x d):.....	189
Physical weight:.....	189
Power consumption:.....	189
Electrical:.....	189
Environmental requirements:.....	189
Certifications:.....	189
ReadyNAS 204 Technical Specifications.....	189
General:.....	189
Physical dimensions (h x w x d):.....	190
Physical weight:.....	190
Power consumption:.....	190
Electrical:.....	190
Environmental requirements:.....	190
Certifications:.....	190
ReadyNAS 214 Technical Specifications.....	191
General:.....	191
Physical dimensions (h x w x d):.....	191
Physical weight:.....	191
Power consumption:.....	191
Electrical:.....	191
Environmental requirements:.....	191
Certifications:.....	192
ReadyNAS 312 Technical Specifications.....	192



## ReadyNAS OS 6 Desktop Storage Systems

General:	192
Physical dimensions (h x w x d):	192
Physical weight:	192
Power consumption:	192
Electrical:	193
Environmental requirements:	193
Certifications:	193
ReadyNAS 314 Technical Specifications	193
General:	193
Physical dimensions (h x w x d):	193
Physical weight:	194
Power consumption:	194
Electrical:	194
Environmental requirements:	194
Certifications:	194
ReadyNAS 316 Technical Specifications	194
General:	194
Physical dimensions (h x w x d):	195
Physical weight:	195
Power consumption:	195
Electrical:	195
Environmental requirements:	195
Certifications:	196
ReadyNAS 422 Technical Specifications	196
General:	196
Physical dimensions (h x w x d):	196
Physical weight:	196
Power consumption:	196
Electrical:	196
Environmental requirements:	197
Certifications:	197
ReadyNAS 424 Technical Specifications	197
General:	197
Physical dimensions (h x w x d):	197
Physical weight:	197
Power consumption:	198
Electrical:	198
Environmental requirements:	198
Certifications:	198
ReadyNAS 426 Technical Specifications	198
General:	198
Physical dimensions (h x w x d):	199
Physical weight:	199
Power consumption:	199
Electrical:	199
Environmental requirements:	199
Certifications:	199
ReadyNAS 428 Technical Specifications	200
General:	200

## ReadyNAS OS 6 Desktop Storage Systems

Physical dimensions (h x w x d):.....	200
Physical weight:.....	200
Power consumption:.....	200
Electrical:.....	200
Environmental requirements:.....	201
Certifications:.....	201
ReadyNAS 516 Technical Specifications.....	201
General:.....	201
Physical dimensions (h x w x d):.....	201
Physical weight:.....	201
Power consumption:.....	202
Electrical:.....	202
Environmental requirements:.....	202
Certifications:.....	202
ReadyNAS 524X Technical Specifications.....	202
General:.....	202
Physical dimensions (h x w x d):.....	203
Physical weight:.....	203
Power consumption:.....	203
Electrical:.....	203
Environmental requirements:.....	203
Certifications:.....	203
ReadyNAS 526X Technical Specifications.....	204
General:.....	204
Physical dimensions (h x w x d):.....	204
Physical weight:.....	204
Power consumption:.....	204
Electrical:.....	204
Environmental requirements:.....	205
Certifications:.....	205
ReadyNAS 528X Technical Specifications.....	205
General:.....	205
Physical dimensions (h x w x d):.....	205
Physical weight:.....	205
Power consumption:.....	206
Electrical:.....	206
Environmental requirements:.....	206
Certifications:.....	206
ReadyNAS 626X Technical Specifications.....	206
General:.....	206
Physical dimensions (h x w x d):.....	207
Physical weight:.....	207
Power consumption:.....	207
Electrical:.....	207
Environmental requirements:.....	207
Certifications:.....	207
ReadyNAS 628X Technical Specifications.....	208
General:.....	208
Physical dimensions (h x w x d):.....	208

## ReadyNAS OS 6 Desktop Storage Systems

Physical weight:.....	208
Power consumption:.....	208
Electrical:.....	208
Environmental requirements:.....	209
Certifications:.....	209
ReadyNAS 716X Technical Specifications.....	209
General:.....	209
Physical dimensions (h x w x d):.....	209
Physical weight:.....	209
Power consumption:.....	210
Electrical:.....	210
Environmental requirements:.....	210
Certifications:.....	210
EDA 500 Technical Specifications.....	210
General:.....	210
Physical dimensions (h x w x d):.....	210
Physical weight:.....	211
Power consumption:.....	211
Electrical:.....	211
Environmental requirements:.....	211
Certifications:.....	211
Safety Warnings.....	211
Electrical Safety Precautions.....	212
General Safety Precautions.....	212
Electrostatic Discharge Precautions.....	212

Congratulations on your purchase of a NETGEAR ReadyNAS® storage system. This manual describes the physical features of the ReadyNAS OS 6 desktop storage systems.

This chapter contains the following sections:

- *Additional Documentation* on page 13
- *Setup Location* on page 13
- *Supported Operating Systems* on page 13
- *Supported Browsers* on page 14
- *Diskless Storage Systems* on page 14

### Additional Documentation

For detailed information about configuring, managing, and using your ReadyNAS storage system, see the *ReadyNAS OS 6 Software Manual*, which is available at [netgear.com/support/product/ReadyNAS\\_OS\\_6](http://netgear.com/support/product/ReadyNAS_OS_6).

NETGEAR maintains a community website that supports ReadyNAS products. Visit [www.netgear.com/readynas](http://www.netgear.com/readynas) for reviews, tutorials, a comparison chart, software updates, documentation, an active user forum, and much more.

### Setup Location

Your ReadyNAS storage system is suitable for use in a home or small office environment where it can be freestanding. The small, compact size makes it suitable for sitting on a desk or on a closet shelf.

Choose a location for your storage system that meets these criteria:

- Cables can be connected easily.
- Water or moisture cannot enter the case.
- Airflow around the storage system and through the vents in the side of the case is not restricted.
- The air is as free of dust as possible.
- Temperature operating limits are not likely to be exceeded.
- If you are using an uninterruptable power supply (UPS) for protection, the power cable can be securely and safely connected to the UPS.

### Supported Operating Systems

The ReadyNAS storage system is supported on the following systems:

- Microsoft Windows 10 (32 bit and 64 bit)
- Microsoft Windows 8.1 (32 bit and 64 bit)
- Microsoft Windows 8 (32 bit and 64 bit)
- Microsoft Windows 7 (32 bit and 64 bit)
- Windows Server 2016 (64 bit)
- Windows Server 2012 R2 (64 bit)
- Microsoft Server 2012 (64 bit)
- Microsoft Server 2008 R2 (64 bit)
- Apple OS X 10.7 or later
- Linux, UNIX, Solaris
- Apple iOS
- Google Android

### Supported Browsers

The ReadyNAS local admin page supports the following browsers:

- Microsoft Edge
- Microsoft Internet Explorer 9.0 and later
- Apple Safari, 5.0 and later
- Google Chrome 20 and later
- Mozilla Firefox 14 and later

If you experience difficulty accessing the local admin page or if you notice unexpected behavior, try using another browser. For more information about the ReadyNAS local admin page, see the *ReadyNAS OS 6 Software Manual*, which is available at [netgear.com/support/product/ReadyNAS\\_OS\\_6](http://netgear.com/support/product/ReadyNAS_OS_6).

### Diskless Storage Systems

If you purchased a ReadyNAS storage system without a preinstalled disk drive or drives, you must add at least one disk your system before you use the system. You can add a 3.5-inch hard disk drive, a 2.5-inch hard disk drive, or a 2.5-inch solid state drive to an empty drive bay. For information about how to install a disk, see [Add a Disk](#) on page 166.

Use only supported SATA hard disk drives (HDD) or solid state drives (SSD) in your ReadyNAS storage system. If you use disks that are not supported, NETGEAR technical support will not provide assistance. For a list of supported disks, see the NETGEAR Hardware Compatibility List at [netgear.com/readynas-hcl](http://netgear.com/readynas-hcl).

If you are adding a previously formatted disk to your storage system, see the instructions in [Previously Formatted Disks](#) on page 165.

This chapter provides an overview of the physical features of the ReadyNAS 102 and includes the following sections:

- *Front and Side Panels* on page 16
- *Drive Bays* on page 16
- *Rear Panel* on page 17
- *Status Information* on page 18
- *Power On and Shut Down* on page 19
- *Boot Menu* on page 20

## Front and Side Panels

The following figure shows the front and side panels of the ReadyNAS 102.

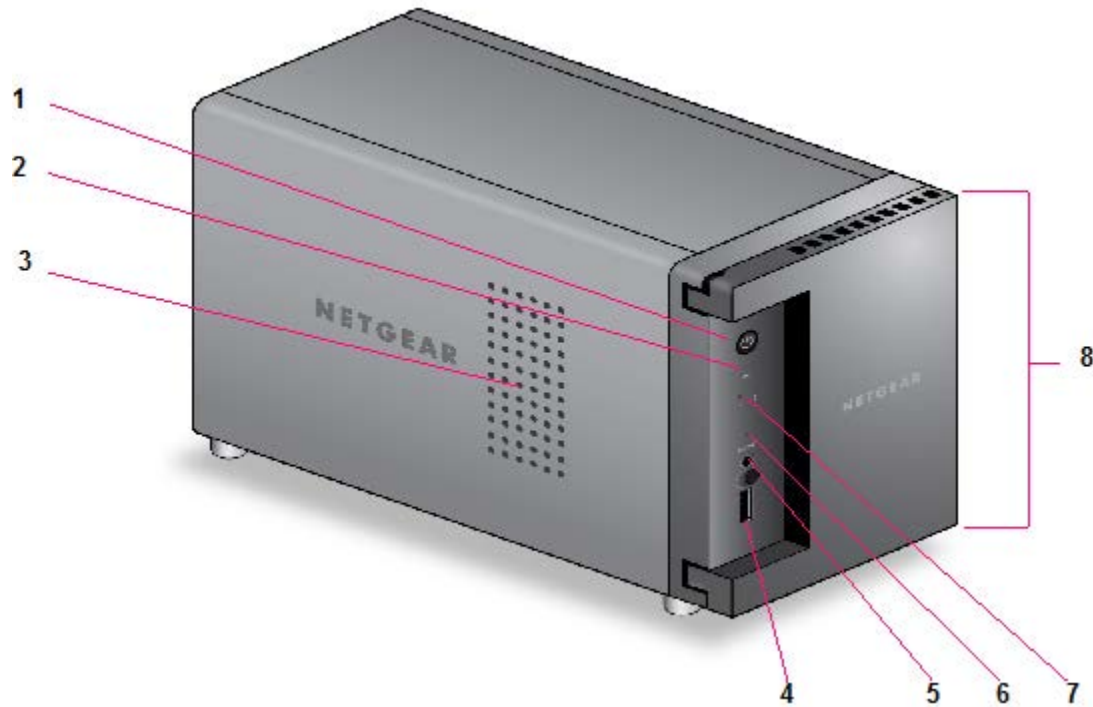

Figure 1. ReadyNAS 102 front and side panels

1. Power button and LED
2. Disk activity LED
3. Exhaust vent
4. USB 2.0 port
5. Backup button
6. USB and Backup status LED
7. Disk 1 and Disk 2 LEDs
8. Drive bay door

## Drive Bays

The following figure shows the drive bays of the ReadyNAS 102.



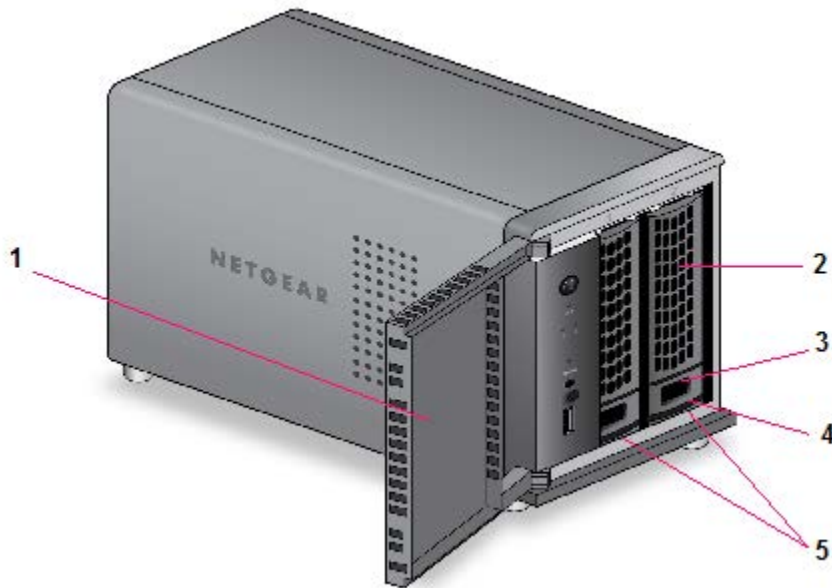

Figure 2. ReadyNAS 102 drive bays

1. Drive bay door
2. Disk tray handle
3. Recessed disk tray handle lock
4. Disk tray release latch
5. Drive bays

## Rear Panel

The following figure shows the rear panel of the ReadyNAS 102.

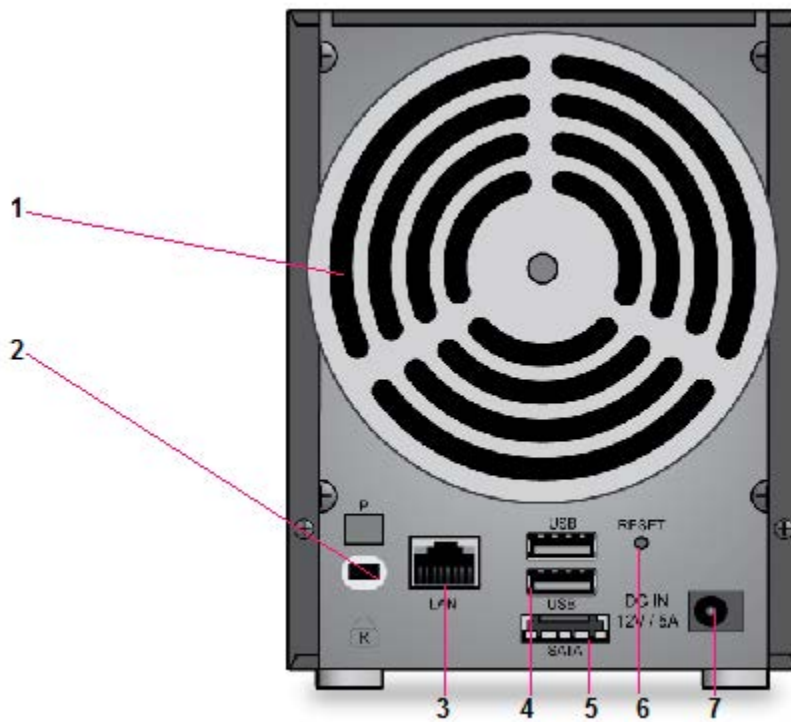

Figure 3. ReadyNAS 102 rear panel

1. Exhaust fan
2. Kensington lock
3. GbE ports with LED status indicators
4. USB 3.0 ports
5. eSATA port
6. Reset button
7. Power adapter socket

## Status Information

You can obtain information about the status of your storage system by reviewing the indicators listed in the following table.

**Table 1. ReadyNAS 102 indicator descriptions**

Indicator	Description
Power button and LED	<p>Press this button to turn on the ReadyNAS. The LED indicates these states:</p> <ul style="list-style-type: none"> <li>• <b>On.</b> Powered on.</li> <li>• <b>Blinking.</b> Booting or shutting down.</li> <li>• <b>Off.</b> Powered off.</li> </ul>
Disk LEDs (1, 2)	<p>An LED on the front panel of the storage system is associated with each drive bay. The disk LEDs have these states:</p> <ul style="list-style-type: none"> <li>• <b>On.</b> Power is on and the disk is operating normally.</li> <li>• <b>Blinking.</b> The disk was removed, failed, or is resynchronizing.</li> <li>• <b>Off.</b> The drive bay is empty.</li> </ul>
Disk activity LED	<p>The disk activity LED has these states:</p> <ul style="list-style-type: none"> <li>• <b>On.</b> At least one disk is present.</li> <li>• <b>Blinking.</b> A disk is active.</li> <li>• <b>Off.</b> All disks are idle.</li> </ul>
Rear panel Ethernet port LEDs	<p>Two LED status indicators are built into this port, one green and one amber. They indicate port speed and activity as follows:</p> <ul style="list-style-type: none"> <li>• <b>Green on, amber off.</b> 1000 Mbps connection speed, no activity.</li> <li>• <b>Green blinking, amber off.</b> 1000 Mbps connection speed, activity.</li> <li>• <b>Green off, amber on.</b> 10 Mbps or 100 Mbps connection speed, no activity.</li> <li>• <b>Green off, amber blinking.</b> 10 Mbps or 100 Mbps connection speed, activity.</li> <li>• <b>Green off, amber off.</b> No connection.</li> </ul>

## Power On and Shut Down

This section describes how to power on and shut down your system. If you must shut down the system, use one of the preferred shutdown methods whenever possible.

### Power On

When you connect the system to a power supply or the system recovers from a power outage, the system returns to its last state:

- If the system was powered on, the system automatically powers on again when the power supply is connected or power is restored.
- If the system was powered off, the system remains off when the power supply is connected or power is restored.  
In this situation, press the **Power** button on the front panel of the system to power on the system.

### Preferred Shutdown

You can gracefully shut down your system by using the Power button or the ReadyNAS local admin page.

For information about how to gracefully shut down your system using the ReadyNAS local admin page, see the *ReadyNAS OS 6 Software Manual*, which is available at [netgear.com/support/product/ReadyNAS\\_OS\\_6](http://netgear.com/support/product/ReadyNAS_OS_6).

#### ▶ To gracefully shut down your system using the Power button:

1. Press the **Power** button.  
The Power LED blinks, prompting you to confirm the shutdown.
2. Press the **Power** button again.  
The system shuts down gracefully.

### Forced Shutdown

Perform a forced shutdown only if the storage system is not responding.

#### ▶ To perform a forced shutdown:

- Unplug the system from the power supply.

### Boot Menu

Use the boot menu to restart or troubleshoot your ReadyNAS storage system. Your storage system has the following boot modes:

- **Normal.** Initiates a normal boot process, just like booting using the **Power** button.
- **Factory default.** Initiates a short disk test that takes approximately 5 minutes. After the disk test, a 10-minute time-out period begins, during which all LEDs blink simultaneously.



#### **WARNING:**

**The factory default reboot process resets the storage system to factory settings, erases all data, resets all defaults, and reformats the disk to X-RAID.**

## ReadyNAS OS 6 Desktop Storage Systems

- If you want to cancel the factory default process, power off the storage system before the 10-minute time-out ends. The system powers down safely without causing any data loss.
- If you want to reset the system to factory default settings, do not power off your system. After the 10-minute time-out period, the factory default process begins.

**Tip** To start the factory default process immediately, press the **Backup** button during the 10-minute time-out period.

- **OS reinstall.** Reinstalls the firmware from the internal flash to the disks. Use the OS reinstall boot mode when the system crashes and corrupts some configuration files. OS reinstall boot mode also resets some settings on your storage system, such as Internet protocol settings and the administrator password, to defaults.
- **Tech support.** Boots into a low-level diagnostic mode. Use the tech support boot mode only when a NETGEAR technical support representative instructs you to do so.
- **Volume read only.** Mounts a volume as read-only. Use this option when you are attempting to rescue data off a disk during a disaster recovery.
- **Memory test.** Performs a memory test. The pass or fail result is reported using the storage system's LEDs. Contact a NETGEAR technical support representative to interpret memory test results.
- **Test disk.** Performs an offline full disk test. This process can take four hours or more, depending on the size of your disks. Any problems are reported in the system logs. For more information about viewing the system logs, see the *ReadyNAS OS 6 Software Manual*, which is available at [netgear.com/support/product/ReadyNAS\\_OS\\_6](http://netgear.com/support/product/ReadyNAS_OS_6).

### ► To access the boot menu:

1. Power off your storage system.
2. Using a straightened paper clip, press and hold the **Reset** button.
3. Press the **Power** button.  
The system powers on.
4. Continue to press the **Reset** button until the Power button LED, USB and backup status LED, disk 1 LED, and disk 2 LED light.
5. Press the **Backup** button to scroll through boot mode options.  
The storage system shows the boot mode options using the LEDs, as described in the following table:

Boot Mode	Status Indicator				
	Description	Power LED	Disk 1 LED	Disk 2 LED	USB and Backup LED
Boot menu	All four LEDs light.	■	■	■	■
Normal	Power LED lights.	■	□	□	□
Factory default	Disk 1 LED lights.	□	■	□	□

**(Continued)**

Boot Mode	Status Indicator				
	Description	Power LED	Disk 1 LED	Disk 2 LED	USB and Backup LED
OS reinstall	Disk 2 LED lights.	<input type="checkbox"/>	<input type="checkbox"/>	<input checked="" type="checkbox"/>	<input type="checkbox"/>
Tech support	USB and backup status LED lights.	<input type="checkbox"/>	<input type="checkbox"/>	<input type="checkbox"/>	<input checked="" type="checkbox"/>
Volume read only	Power LED and disk 1 LED light.	<input checked="" type="checkbox"/>	<input checked="" type="checkbox"/>	<input type="checkbox"/>	<input type="checkbox"/>
Memory test	Power LED and disk 2 LED light.	<input checked="" type="checkbox"/>	<input type="checkbox"/>	<input checked="" type="checkbox"/>	<input type="checkbox"/>
Test disk	Power LED and USB and backup status LED light.	<input checked="" type="checkbox"/>	<input type="checkbox"/>	<input type="checkbox"/>	<input checked="" type="checkbox"/>

Legend:

- On:
- Off:

6. Press and release the **Reset** button to confirm your boot menu selection.  
The system boots in the selected boot mode.

This chapter provides an overview of the physical features of the ReadyNAS 104 and includes the following sections:

- *Front and Side Panels* on page 24
- *Drive Bays* on page 24
- *Rear Panel* on page 25
- *Status Information* on page 26
- *Power On and Shut Down* on page 27
- *Boot Menu* on page 28

## Front and Side Panels

The following figure shows the front and side panels of the ReadyNAS 104.

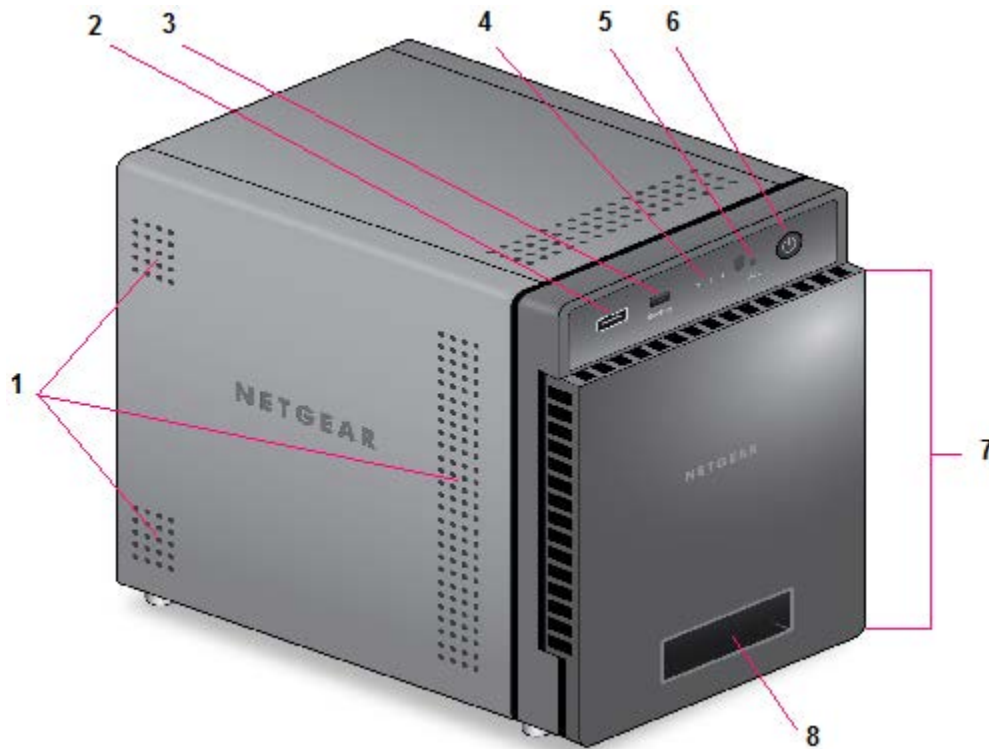

Figure 4. ReadyNAS 104 front and side panels

1. Exhaust vents
2. USB 2.0 port
3. Backup button and LED
4. Disk LEDs
5. Disk activity LED
6. Power button and LED
7. Drive bay door
8. Status display screen

## Drive Bays

The following figure shows the drive bays of the ReadyNAS 104.



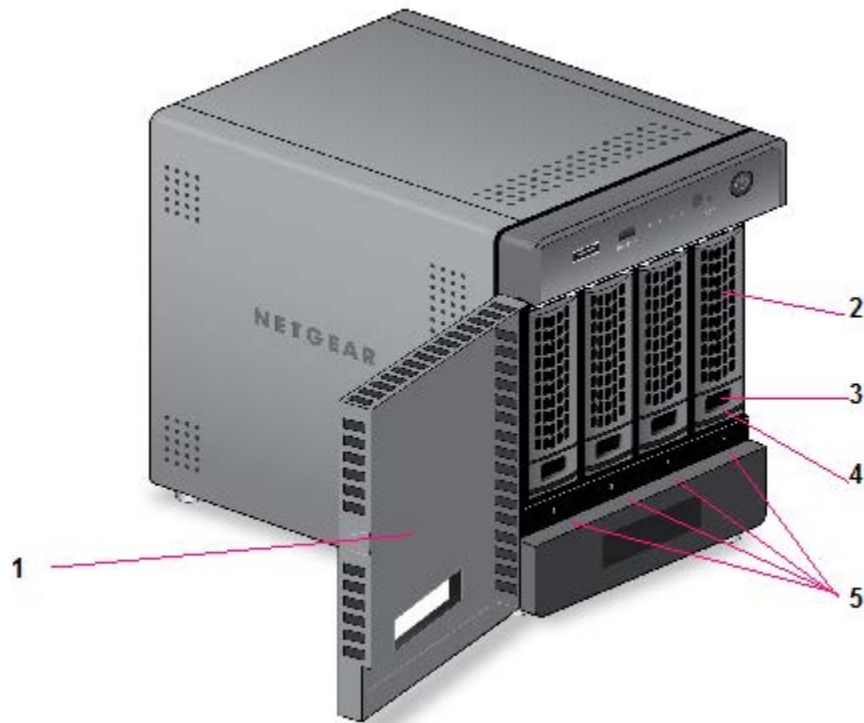

Figure 5. ReadyNAS 104 drive bays

1. Drive bay door
2. Disk tray handle
3. Recessed disk tray handle lock
4. Disk tray release latch
5. Drive bays

## Rear Panel

The following figure shows the rear panel of the ReadyNAS 104.

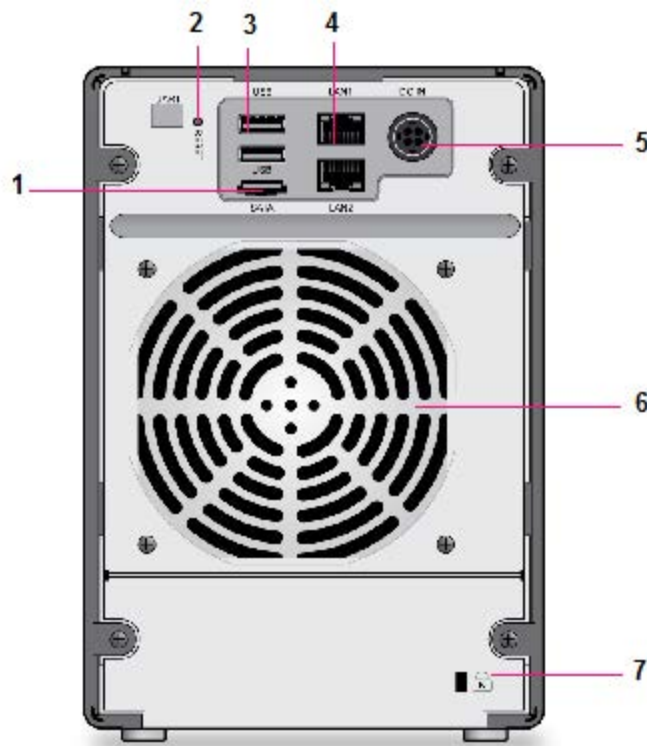

Figure 6. ReadyNAS 104 rear panel

1. eSATA port
2. Reset button
3. USB 3.0 ports
4. GbE ports with LED status indicators

---

**Note** The two GbE ports are equivalent. They can be used as two separate Ethernet connections, or can be configured as a single, bonded port with a 2 Gbps potential speed. For information about how to configure a bonded port, and the network configuration requirements needed to support 2 Gbps, see the *ReadyNAS OS 6 Software Manual*, which is available at [netgear.com/support/product/ReadyNAS\\_OS\\_6](http://netgear.com/support/product/ReadyNAS_OS_6).

---

5. Power cable socket
6. Exhaust fan
7. Kensington lock

## Status Information

You can obtain information about the status of your storage system by reviewing the indicators listed in the following table.

**Table 2. ReadyNAS 104 indicator descriptions**

Indicator	Description
Power button and LED	<p>Press this button to turn on the ReadyNAS. The LED indicates these states:</p> <ul style="list-style-type: none"> <li>• <b>On.</b> Powered on.</li> <li>• <b>Blinking.</b> Booting or shutting down.</li> <li>• <b>Off.</b> Powered off.</li> </ul>
Disk LEDs (1, 2, 3, 4)	<p>An LED on the top of the front panel is associated with each drive bay. LEDs are in numerical order from left to right. The disk LEDs indicate these states:</p> <ul style="list-style-type: none"> <li>• <b>On.</b> Power is on and the disk is operating normally.</li> <li>• <b>Blinking.</b> The disk was removed, failed, or is resynchronizing. See the display screen for details.</li> <li>• <b>Off.</b> The drive bay is empty.</li> </ul>
Disk activity LED	<p>The disk activity LED indicates these states:</p> <ul style="list-style-type: none"> <li>• <b>On.</b> At least one disk is present.</li> <li>• <b>Blinking.</b> A disk is active.</li> <li>• <b>Off.</b> All disks are idle.</li> </ul>
Rear panel Ethernet port LEDs	<p>Two LED status indicators are built into this port, one green and one amber. They indicate port speed and activity as follows:</p> <ul style="list-style-type: none"> <li>• <b>Green on, amber off.</b> 1000 Mbps connection speed, no activity.</li> <li>• <b>Green blinking, amber off.</b> 1000 Mbps connection speed, activity.</li> <li>• <b>Green off, amber on.</b> 10 Mbps or 100 Mbps connection speed, no activity.</li> <li>• <b>Green off, amber blinking.</b> 10 Mbps or 100 Mbps connection speed, activity.</li> <li>• <b>Green off, amber off.</b> No connection.</li> </ul>
Status display screen	<p>Displays messages about the status of your storage system. Note that the status display screen goes to sleep to prevent burn-in. To wake it, press the <b>Power</b> button once. If the storage system reports an abnormal operation or error, the status display screen stays on.</p>

## Power On and Shut Down

This section describes how to power on and shut down your system. If you need to shut down the system, use one of the preferred shutdown methods whenever possible.

### Power On

When you connect the system to a power supply or the system recovers from a power outage, the system returns to its last state:

- If the system was powered on, the system automatically powers on again when the power supply is connected or power is restored.
- If the system was powered off, the system remains off when the power supply is connected or power is restored.  
In this situation, press the **Power** button on the front panel of the system to power on the system.

### Preferred Shutdown

You can gracefully shut down your system by using the **Power** button or the ReadyNAS local admin page.

For information about how to gracefully shut down your system using the ReadyNAS local admin page, see the *ReadyNAS OS 6 Software Manual*, which is available at [netgear.com/support/product/ReadyNAS\\_OS\\_6](http://netgear.com/support/product/ReadyNAS_OS_6).

#### ▶ To gracefully shut down your system using the Power button:

1. If the status display screen is not lit, do the following:
  - a. Press the **Power** button.  
The status display screen wakes.
  - b. Press the **Power** button a second time.  
Instructions for graceful shutdown display on the status display screen.
  - c. Press the **Power** button a third time.  
The system shuts down gracefully.
2. If the status display screen is lit, do the following:
  - a. Press the **Power** button.  
Instructions for graceful shutdown display on the status display screen.
  - b. Press the **Power** button again.  
The system shuts down gracefully.

### Forced Shutdown

Perform a forced shutdown only if the storage system is not responding.

#### ▶ To perform a forced shutdown:

- Unplug the system from the power supply.

### Boot Menu

Use the boot menu to restart or troubleshoot your ReadyNAS storage system. Your storage system has the following boot modes:

## ReadyNAS OS 6 Desktop Storage Systems

- **Normal.** Initiates a normal boot process, just like booting using the Power button.
- **Factory default.** Initiates a short disk test that takes approximately 5 minutes. After the disk test, a 10-minute time-out period begins, during which all LEDs blink simultaneously.



### **WARNING:**

The factory default reboot process resets the storage system to factory settings, erases all data, resets all defaults, and reformats the disk to X-RAID.

- If you want to cancel the factory default process, power off the storage system before the 10-minute time-out ends. The system powers down safely without causing any data loss.
- If you want to reset the system to factory default settings, do not power off your system. After the 10-minute time-out period, the factory default process begins.

**Tip** To start the factory default process immediately, press the **Backup** button during the 10-minute time-out period.

- **OS reinstall.** Reinstalls the firmware from the internal flash to the disks. Use the OS reinstall boot mode when the system crashes and corrupts some configuration files. OS reinstall boot mode also resets some settings on your storage system, such as Internet protocol settings and the administrator password, to defaults.
- **Tech support.** Boots into a low-level diagnostic mode. Use the tech support boot mode only when a NETGEAR technical support representative instructs you to do so.
- **Volume read only.** Mounts a volume as read-only. Use this option when you are attempting to rescue data off a disk during a disaster recovery.
- **Memory test.** Performs a memory test. The pass or fail result is reported on the status display screen.
- **Test disk.** Performs an offline full disk test. This process can take four hours or more, depending on the size of your disks. Any problems are reported in the system logs. For more information about viewing the system logs, see the *ReadyNAS OS 6 Software Manual*, which is available at [netgear.com/support/product/ReadyNAS\\_OS\\_6](http://netgear.com/support/product/ReadyNAS_OS_6).

### ▶ **To access the boot menu:**

1. Power off your storage system.
2. Using a straightened paper clip, press and hold the **Reset** button.
3. Press the **Power** button.  
The system powers on.
4. Continue to press the **Reset** button until the status display screen shows a boot menu message.
5. Press the **Backup** button to scroll through boot mode options.  
The status display screen shows the current boot mode option.
6. When the status display screen shows the boot mode that you need, press and release the **Reset** button to confirm your boot menu selection.  
The system boots in the selected boot mode.

This chapter provides an overview of the physical features of the ReadyNAS 202 and includes the following sections:

- *Front and Side Panels* on page 31
- *Drive Bays* on page 31
- *Rear Panel* on page 32
- *Status Information* on page 33
- *Power On and Shut Down* on page 34
- *Boot Menu* on page 35

## Front and Side Panels

The following figure shows the front and side panels of the ReadyNAS 202.

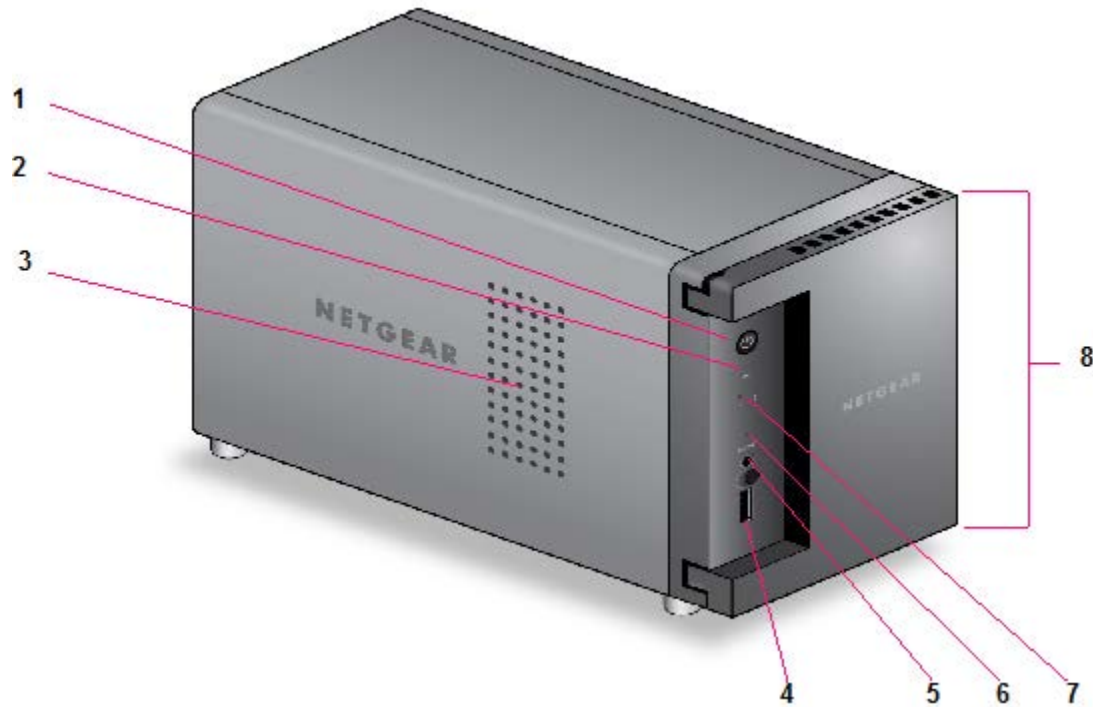

Figure 7. ReadyNAS 202 front and side panels

1. Power button and LED
2. Disk activity LED
3. Exhaust vent
4. USB 3.0 port
5. Backup button
6. USB and backup status LED
7. Disk 1 and Disk 2 LEDs
8. Drive bay door

## Drive Bays

The following figure shows the drive bays of the ReadyNAS 202.



Figure 8. ReadyNAS 202 drive bays

1. Drive bay door
2. Disk tray handle
3. Recessed disk tray handle lock
4. Disk tray release latch
5. Drive bays

## Rear Panel

The following figure shows the rear panel of the ReadyNAS 202.



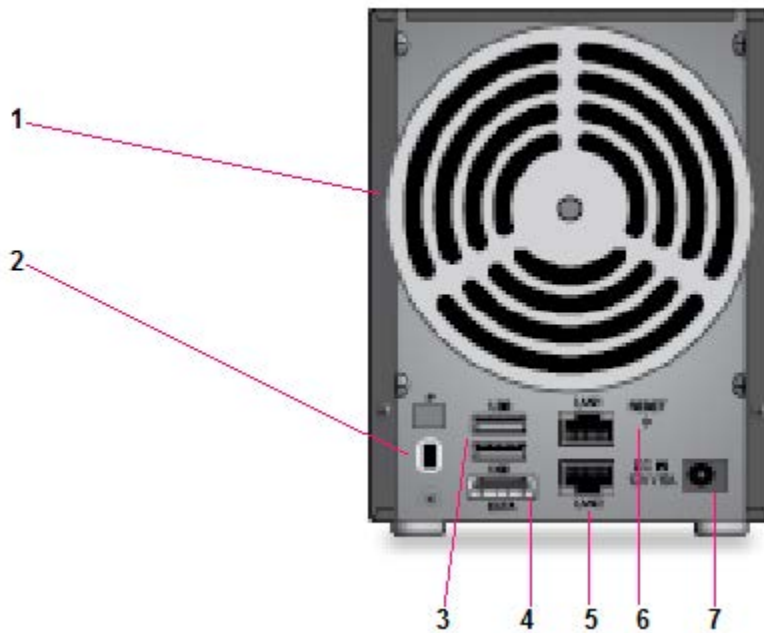

Figure 9. ReadyNAS 202 rear panel

1. Exhaust fan
2. Kensington lock
3. USB 3.0 ports
4. eSATA port
5. GbE ports with LED status indicators

---

**Note** The two GbE ports are equivalent. They can be used as two separate Ethernet connections, or can be configured as a single, bonded port with a 2 Gbps potential speed. For information on how to configure a bonded port, and the network configuration requirements needed to support 2 Gbps, see the *ReadyNAS OS 6 Software Manual*, which is available at [netgear.com/support/product/ReadyNAS\\_OS\\_6](http://netgear.com/support/product/ReadyNAS_OS_6).

---

6. Reset button
7. Power adapter socket

## Status Information

You can obtain information about the status of your storage system by reviewing the indicators listed in the following table.

**Table 3. ReadyNAS 202 indicator descriptions**

Indicator	Description
Power button and LED	<p>Press this button to turn on the ReadyNAS. The LED has these states:</p> <ul style="list-style-type: none"> <li>• <b>On.</b> Powered on.</li> <li>• <b>Blinking.</b> Booting or shutting down.</li> <li>• <b>Off.</b> Powered off.</li> </ul>
Disk LEDs (1, 2)	<p>Each drive bay has an LED associated with it on the front panel of the storage system. The disk LEDs have these states:</p> <ul style="list-style-type: none"> <li>• <b>On.</b> Power is on and the disk is operating normally.</li> <li>• <b>Blinking.</b> The disk was removed, failed, or is resynchronizing. See the display screen for details.</li> <li>• <b>Off.</b> The drive bay is empty.</li> </ul>
Disk activity LED	<p>The disk activity LED has these states:</p> <ul style="list-style-type: none"> <li>• <b>Blinking.</b> A disk is active.</li> <li>• <b>Off.</b> Disk is idling.</li> </ul>
Rear panel Ethernet port LEDs	<p>Two LED status indicators are built into each port, one off or green and one showing three states: off, amber, or green. They indicate port speed and activity as follows:</p> <ul style="list-style-type: none"> <li>• <b>Green, green.</b> 1000 Mbps connection speed, no activity.</li> <li>• <b>Green blinking, green.</b> 1000 Mbps connection speed, activity.</li> <li>• <b>Green, amber.</b> 100 Mbps connection speed, no activity.</li> <li>• <b>Green blinking, amber.</b> 100 Mbps connection speed, activity.</li> <li>• <b>Green on, off.</b> 10 Mbps connection speed, no activity.</li> <li>• <b>Green blinking, off.</b> 10 Mbps connection speed, activity.</li> <li>• <b>Off, off.</b> No connection.</li> </ul>

## Power On and Shut Down

This section describes how to power on and shut down your system. If you must shut down the system, use one of the preferred shutdown methods whenever possible.

### Power On

When you connect the system to a power supply or the system recovers from a power outage, the system returns to its last state:

- If the system was powered on, the system automatically powers on again when the power supply is connected or power is restored.
- If the system was powered off, the system remains off when the power supply is connected or power is restored.  
In this situation, press the **Power** button on the front panel of the system to power on the system.

### Preferred Shutdown

You can gracefully shut down your system by using the **Power** button or the ReadyNAS local admin page.

For information about how to gracefully shut down your system using the ReadyNAS local admin page, see the *ReadyNAS OS 6 Software Manual*, which is available at [netgear.com/support/product/ReadyNAS\\_OS\\_6](http://netgear.com/support/product/ReadyNAS_OS_6).

#### ▶ To gracefully shut down your system using the Power button:

1. Press the **Power** button.  
The Power LED blinks, prompting you to confirm the shutdown.
2. Press the **Power** button again.  
The system shuts down gracefully.

### Forced Shutdown

Perform a forced shutdown only if the storage system is not responding.

#### ▶ To perform a forced shutdown:

- Unplug the system from the power supply.

### Boot Menu

Use the boot menu to restart or troubleshoot your ReadyNAS storage system. Your storage system has the following boot modes:

- **Normal.** Initiates a normal boot process, just like booting using the **Power** button.
- **Factory default.** Initiates a short disk test that takes approximately 5 minutes. After the disk test, a 10-minute time-out period begins, during which all LEDs blink simultaneously.



#### **WARNING:**

The factory default reboot process resets the storage system to factory settings, erases all data, resets all defaults, and reformats the disk to X-RAID.

## ReadyNAS OS 6 Desktop Storage Systems

- If you want to cancel the factory default process, power off the storage system before the 10-minute time-out ends. The system powers down safely without causing any data loss.
- If you want to reset the system to factory default settings, do not power off your system. After the 10-minute time-out period, the factory default process begins.

**Tip** To start the factory default process immediately, press the **Backup** button during the 10-minute time-out period.

- **OS reinstall.** Reinstalls the firmware from the internal flash to the disks. Use the OS reinstall boot mode when the system crashes and corrupts some configuration files. OS reinstall boot mode also resets some settings on your storage system, such as Internet protocol settings and the administrator password, to defaults.
- **Tech support.** Boots into a low-level diagnostic mode. Use the tech support boot mode only when a NETGEAR technical support representative instructs you to do so.
- **Volume read only.** Mounts a volume as read-only. Use this option when you are attempting to rescue data off a disk during a disaster recovery.
- **Memory test.** Performs a memory test. The memory test runs for eight hours. The current status and the pass or fail result is reported using the storage system LEDs, as described in the following table:

Figure 10. Memory Test Status

Memory Test State	Power LED	Disk 1 LED	Disk 2 LED	Backup LED
1st hour	Off	Off	Off	Blinking
2nd hour	Off	Off	Blinking	Off
3rd hour	Off	Blinking	Off	Off
4th hour	Off	Blinking	Blinking	Blinking
5th hour	On	Off	Off	Blinking
6th hour	On	Off	Blinking	Off
7th hour	On	Blinking	Off	Off
8th hour	On	Blinking	Blinking	Blinking
Result: fail	Blinking	Blinking	Blinking	Blinking
Result: pass	On	On	On	On

- **Test disk.** Performs an offline full disk test. This process can take four hours or more, depending on the size of your disks. Any problems are reported in the system logs. For more information about viewing the system logs, see the *ReadyNAS OS 6 Software Manual*, which is available at [netgear.com/support/product/ReadyNAS\\_OS\\_6](http://netgear.com/support/product/ReadyNAS_OS_6).

## ReadyNAS OS 6 Desktop Storage Systems

### ▶ To access the boot menu:

1. Power off your storage system.
2. Using a straightened paper clip, press and hold the **Reset** button.
3. Press the **Power** button.  
The system powers on.
4. Continue to press the **Reset** button until the Power LED, USB and backup status LED, disk 1 LED, and disk 2 LED light.
5. Press the **Backup** button to scroll through boot mode options.  
The storage system shows the boot mode options using the LEDs, as described in the following table:

Boot Mode	Status Indicator				
	Description	Power LED	Disk 1 LED	Disk 2 LED	USB and Backup LED
Boot menu	All four LEDs light.	■	■	■	■
Normal	Power LED lights.	■	□	□	□
Factory default	Disk 1 LED lights.	□	■	□	□
OS reinstall	Disk 2 LED lights.	□	□	■	□
Tech support	USB and backup status LED lights.	□	□	□	■
Volume read only	Power LED and disk 1 LED light.	■	■	□	□
Memory test	Power LED and disk 2 LED light.	■	□	■	□
Test disk	Power LED and USB and backup status LED light.	■	□	□	■

Legend:

- On: ■
- Off: □

6. Press and release the **Reset** button to confirm your boot menu selection.  
The system boots in the selected boot mode.

This chapter provides an overview of the physical features of the ReadyNAS 204 and includes the following sections:

- *Front and Side Panels* on page 39
- *Drive Bays* on page 39
- *Rear Panel* on page 40
- *Status Information* on page 41
- *Power On and Shut Down* on page 42
- *Boot Menu* on page 43

## Front and Side Panels

The following figure shows the front and side panels of the ReadyNAS 204.

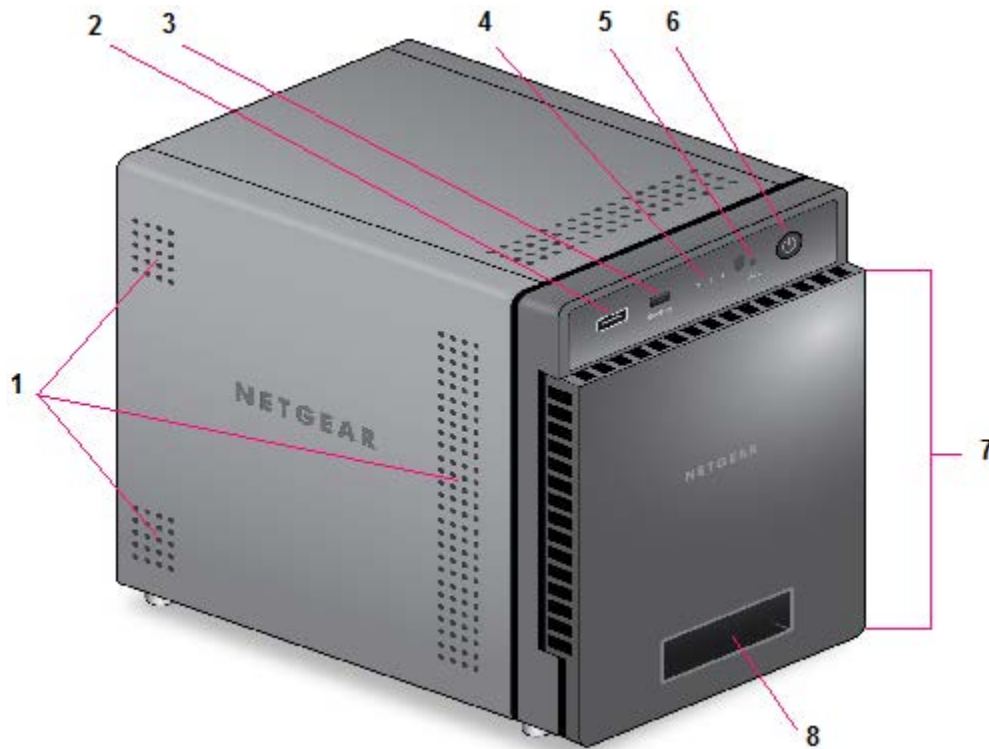

Figure 11. ReadyNAS 204 front and side panels

1. Exhaust vents
2. USB 2.0 port
3. Backup button and LED
4. Disk LEDs
5. Disk activity LED
6. Power button and LED
7. Drive bay door
8. Status display screen

## Drive Bays

The following figure shows the drive bays of the ReadyNAS 204.

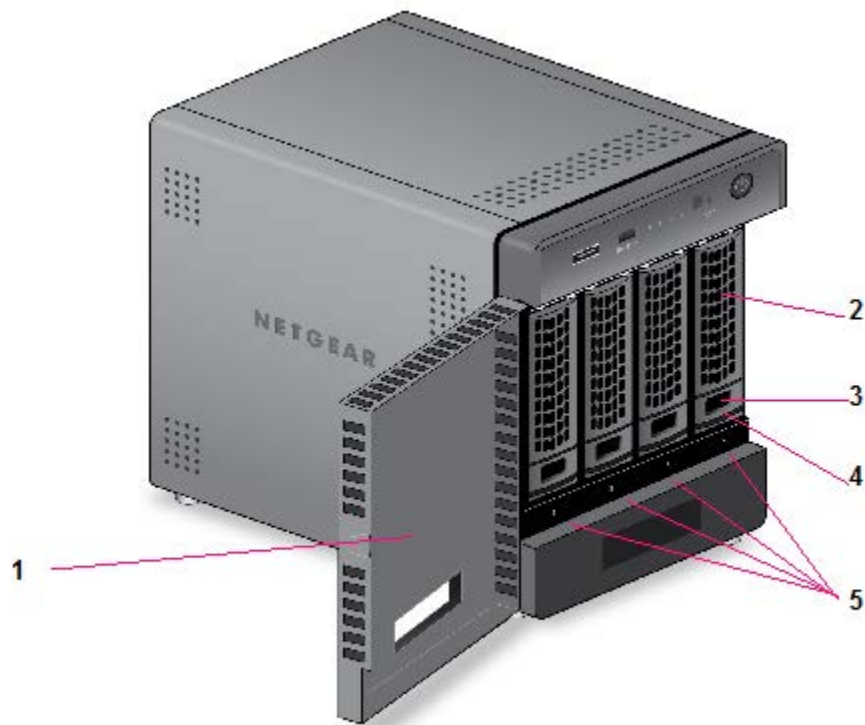

Figure 12. ReadyNAS 204 drive bays

1. Drive bay door
2. Disk tray handle
3. Recessed disk tray handle lock
4. Disk tray release latch
5. Drive bays

## Rear Panel

The following figure shows the rear panel of the ReadyNAS 204.



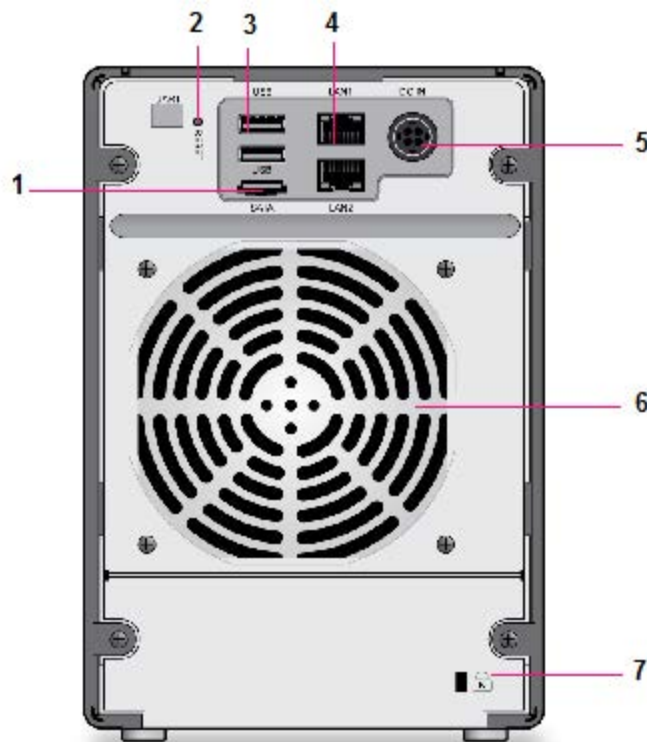

Figure 13. ReadyNAS 204 rear panel

1. eSATA port
2. Reset button
3. USB 3.0 ports
4. LAN ports with LED status indicators

---

**Note** The two LAN ports are equivalent. They can be used as two separate Ethernet connections, or can be configured as a single, bonded port with a 2 Gbps potential speed. For information about how to configure a bonded port, and the network configuration requirements needed to support 2 Gbps, see the *ReadyNAS OS 6 Software Manual*, which is available at [netgear.com/support/product/ReadyNAS\\_OS\\_6](http://netgear.com/support/product/ReadyNAS_OS_6).

---

5. Power cable socket
6. Exhaust fan
7. Kensington lock

## Status Information

You can obtain information about the status of your storage system by reviewing the indicators listed in the following table.

**Table 4. ReadyNAS 204 indicator descriptions**

Indicator	Description
Power button and LED	<p>Press this button to turn on the ReadyNAS. The LED indicates these states:</p> <ul style="list-style-type: none"> <li>• <b>On.</b> Powered on.</li> <li>• <b>Blinking.</b> Booting or shutting down.</li> <li>• <b>Off.</b> Powered off.</li> </ul>
Disk LEDs (1, 2, 3, 4)	<p>An LED on the top of the front panel is associated with each drive bay. LEDs are in numerical order from left to right. The disk LEDs indicate these states:</p> <ul style="list-style-type: none"> <li>• <b>On.</b> Power is on and the disk is operating normally.</li> <li>• <b>Blinking.</b> The disk was removed, failed, or is resynchronizing. See the display screen for details.</li> <li>• <b>Off.</b> The drive bay is empty.</li> </ul>
Disk activity LED	<p>The disk activity LED indicates these states:</p> <ul style="list-style-type: none"> <li>• <b>Blinking.</b> A disk is being accessed.</li> <li>• <b>Off.</b> All disks are idle.</li> </ul>
Rear panel Ethernet port LEDs	<p>Two LED status indicators are built into each port, one off or green and one showing three states: off, amber, or green. They indicate port speed and activity as follows:</p> <ul style="list-style-type: none"> <li>• <b>Green, green.</b> 1000 Mbps connection speed, no activity.</li> <li>• <b>Green blinking, green.</b> 1000 Mbps connection speed, activity.</li> <li>• <b>Green, amber.</b> 100 Mbps connection speed, no activity.</li> <li>• <b>Green blinking, amber.</b> 100 Mbps connection speed, activity.</li> <li>• <b>Green on, off.</b> 10 Mbps connection speed, no activity.</li> <li>• <b>Green blinking, off.</b> 10 Mbps connection speed, activity.</li> <li>• <b>Off, off.</b> No connection.</li> </ul>
Status display screen	<p>Displays messages about the status of your storage system. Note that the status display screen goes to sleep to prevent burn-in. To wake it, press the <b>Power</b> button once. If the storage system reports an abnormal operation or error, the status display screen stays on.</p>

## Power On and Shut Down

This section describes how to power on and shut down your system. If you must shut down the system, use one of the preferred shutdown methods whenever possible.

### Power On

When you connect the system to a power supply or the system recovers from a power outage, the system returns to its last state:

- If the system was powered on, the system automatically powers on again when the power supply is connected or power is restored.
- If the system was powered off, the system remains off when the power supply is connected or power is restored.  
In this situation, press the **Power** button on the front panel of the system to power on the system.

### Preferred Shutdown

You can gracefully shut down your system by using the **Power** button or the ReadyNAS local admin page.

For information about how to gracefully shut down your system using the ReadyNAS local admin page, see the *ReadyNAS OS 6 Software Manual*, which is available at [netgear.com/support/product/ReadyNAS\\_OS\\_6](http://netgear.com/support/product/ReadyNAS_OS_6).

#### ► To gracefully shut down your system using the Power button:

1. If the status display screen is not lit, do the following:
  - a. Press the **Power** button.  
The status display screen wakes.
  - b. Press the **Power** button a second time.  
Instructions for graceful shutdown display on the status display screen.
  - c. Press the **Power** button a third time.  
The system shuts down gracefully.
2. If the status display screen is lit, do the following:
  - a. Press the **Power** button.  
Instructions for graceful shutdown display on the status display screen.
  - b. Press the **Power** button again.  
The system shuts down gracefully.

### Forced Shutdown

Perform a forced shutdown only if the storage system is not responding.

#### ► To perform a forced shutdown:

- Unplug the system from the power supply.

### Boot Menu

Use the boot menu to restart or troubleshoot your ReadyNAS storage system. Your storage system has the following boot modes:

## ReadyNAS OS 6 Desktop Storage Systems

- **Normal.** Initiates a normal boot process, just like booting using the Power button.
- **Factory default.** Initiates a short disk test that takes approximately 5 minutes. After the disk test, a 10-minute time-out period begins, during which all LEDs blink simultaneously.



### **WARNING:**

**The factory default reboot process resets the storage system to factory settings, erases all data, resets all defaults, and reformats the disk to X-RAID.**

- If you want to cancel the factory default process, power off the storage system before the 10-minute time-out ends. The system powers down safely without causing any data loss.
- If you want to reset the system to factory default settings, do not power off your system. After the 10-minute time-out period, the factory default process begins.

**Tip** To start the factory default process immediately, press the **Backup** button during the 10-minute time-out period.

- **OS reinstall.** Reinstalls the firmware from the internal flash to the disks. Use the OS reinstall boot mode when the system crashes and corrupts some configuration files. OS reinstall boot mode also resets some settings on your storage system, such as Internet protocol settings and the administrator password, to defaults.
- **Tech support.** Boots into a low-level diagnostic mode. Use the tech support boot mode only when a NETGEAR technical support representative instructs you to do so.
- **Volume read only.** Mounts a volume as read-only. Use this option when you are attempting to rescue data off a disk during a disaster recovery.
- **Memory test.** Performs a memory test. The pass or fail result is reported on the status display screen.
- **Test disk.** Performs an offline full disk test. This process can take four hours or more, depending on the size of your disks. Any problems are reported in the system logs. For more information about viewing the system logs, see the *ReadyNAS OS 6 Software Manual*, which is available at [netgear.com/support/product/ReadyNAS\\_OS\\_6](http://netgear.com/support/product/ReadyNAS_OS_6).

### ▶ **To access the boot menu:**

1. Power off your storage system.
2. Using a straightened paper clip, press and hold the **Reset** button.
3. Press the **Power** button.  
The system powers on.
4. Continue to press the **Reset** button until the status display screen shows a boot menu message.
5. Press the **Backup** button to scroll through boot mode options.  
The status display screen shows the current boot mode option.
6. When the status display screen shows the boot mode that you need, press and release the **Reset** button to confirm your boot menu selection.  
The system boots in the selected boot mode.

This chapter provides an overview of the physical features of the ReadyNAS 212 and includes the following sections:

- *Front and Side Panels* on page 46
- *Drive Bays* on page 46
- *Rear Panel* on page 47
- *Status Information* on page 48
- *Power On and Shut Down* on page 49
- *Boot Menu* on page 50

## Front and Side Panels

The following figure shows the front and side panels of the ReadyNAS 212.

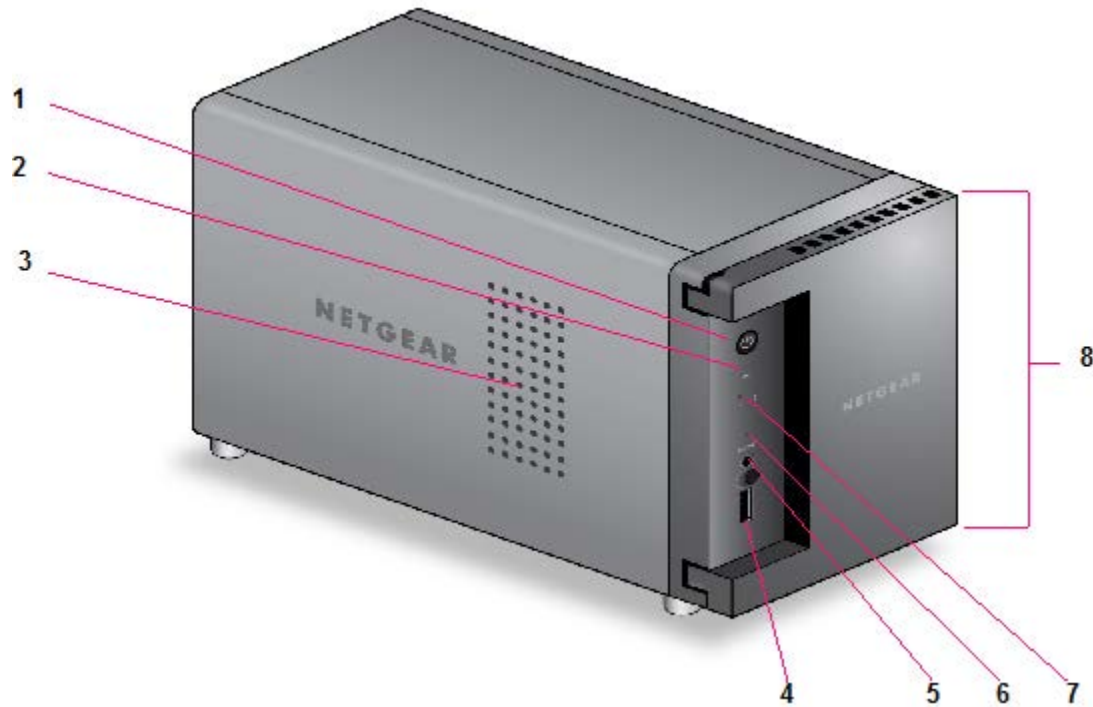

Figure 14. ReadyNAS 212 front and side panels

1. Power button and LED
2. Disk activity LED
3. Exhaust vent
4. USB 3.0 port
5. Backup button
6. USB and backup status LED
7. Disk 1 and Disk 2 LEDs
8. Drive bay door

## Drive Bays

The following figure shows the drive bays of the ReadyNAS 212.



Figure 15. ReadyNAS 212 drive bays

1. Drive bay door
2. Disk tray handle
3. Recessed disk tray handle lock
4. Disk tray release latch
5. Drive bays

## Rear Panel

The following figure shows the rear panel of the ReadyNAS 212.

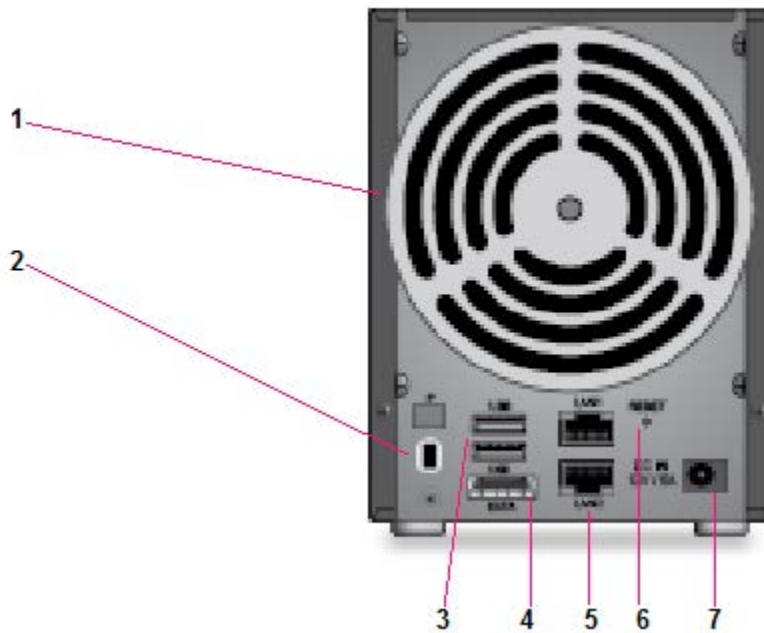

Figure 16. ReadyNAS 212 rear panel

1. Exhaust fan
2. Kensington lock
3. USB 3.0 ports
4. eSATA port
5. GbE ports with LED status indicators

---

**Note** The two GbE ports are equivalent. They can be used as two separate Ethernet connections, or can be configured as a single, bonded port with a 2 Gbps potential speed. For information about how to configure a bonded port, and the network configuration requirements needed to support 2 Gbps, see the *ReadyNAS OS 6 Software Manual*, which is available at [netgear.com/support/product/ReadyNAS\\_OS\\_6](http://netgear.com/support/product/ReadyNAS_OS_6).

---

6. Reset button
7. Power adapter socket

## Status Information

You can obtain information about the status of your storage system by reviewing the indicators listed in the following table.



**Table 5. ReadyNAS 212 indicator descriptions**

Indicator	Description
Power button and LED	<p>Press this button to turn on the ReadyNAS. The LED indicates these states:</p> <ul style="list-style-type: none"> <li>• <b>On.</b> Powered on.</li> <li>• <b>Blinking.</b> Booting or shutting down.</li> <li>• <b>Off.</b> Powered off.</li> </ul>
Disk LEDs (1, 2)	<p>An LED on the front panel of the storage system is associated with each drive bay The disk LEDs indicate these states:</p> <ul style="list-style-type: none"> <li>• <b>On.</b> Power is on and the disk is operating normally.</li> <li>• <b>Blinking.</b> The disk was removed, failed, or is resynchronizing. See the display screen for details.</li> <li>• <b>Off.</b> The drive bay is empty.</li> </ul>
Disk activity LED	<p>The disk activity LED indicates these states:</p> <ul style="list-style-type: none"> <li>• <b>Blinking.</b> A disk is active.</li> <li>• <b>Off.</b> disk is idling.</li> </ul>
Rear panel Ethernet port LEDs	<p>Two LED status indicators are built into each port, one off or green and one showing three states: off, amber, or green. They indicate port speed and activity as follows:</p> <ul style="list-style-type: none"> <li>• <b>Green, green.</b> 1000 Mbps connection speed, no activity.</li> <li>• <b>Green blinking, green.</b> 1000 Mbps connection speed, activity.</li> <li>• <b>Green, amber.</b> 100 Mbps connection speed, no activity.</li> <li>• <b>Green blinking, amber.</b> 100 Mbps connection speed, activity.</li> <li>• <b>Green on, off.</b> 10 Mbps connection speed, no activity.</li> <li>• <b>Green blinking, off.</b> 10 Mbps connection speed, activity.</li> <li>• <b>Off, off.</b> No connection.</li> </ul>

## Power On and Shut Down

This section describes how to power on and shut down your system. If you must shut down the system, use one of the preferred shutdown methods whenever possible.

### Power On

When you connect the system to a power supply or the system recovers from a power outage, the system returns to its last state:

- If the system was powered on, the system automatically powers on again when the power supply is connected or power is restored.
- If the system was powered off, the system remains off when the power supply is connected or power is restored.  
In this situation, press the **Power** button on the front panel of the system to power on the system.

### Preferred Shutdown

You can gracefully shut down your system by using the **Power** button or the ReadyNAS local admin page.

For information about how to gracefully shut down your system using the ReadyNAS local admin page, see the *ReadyNAS OS 6 Software Manual*, which is available at [netgear.com/support/product/ReadyNAS\\_OS\\_6](http://netgear.com/support/product/ReadyNAS_OS_6).

#### ▶ To gracefully shut down your system using the Power button:

1. Press the **Power** button.  
The Power LED blinks, prompting you to confirm the shutdown.
2. Press the **Power** button again.  
The system shuts down gracefully.

### Forced Shutdown

Perform a forced shutdown only if the storage system is not responding.

#### ▶ To perform a forced shutdown:

- Unplug the system from the power supply.

### Boot Menu

Use the boot menu to restart or troubleshoot your ReadyNAS storage system. Your storage system has the following boot modes:

- **Normal.** Initiates a normal boot process, just like booting using the **Power** button.
- **Factory default.** Initiates a short disk test that takes approximately 5 minutes. After the disk test, a 10-minute time-out period begins, during which all LEDs blink simultaneously.



#### **WARNING:**

The factory default reboot process resets the storage system to factory settings, erases all data, resets all defaults, and reformats the disk to X-RAID.

## ReadyNAS OS 6 Desktop Storage Systems

- If you want to cancel the factory default process, power off the storage system before the 10-minute time-out ends. The system powers down safely without causing any data loss.
- If you want to reset the system to factory default settings, do not power off your system. After the 10-minute time-out period, the factory default process begins.

**Tip** To start the factory default process immediately, press the **Backup** button during the 10-minute time-out period.

- **OS reinstall.** Reinstalls the firmware from the internal flash to the disks. Use the OS reinstall boot mode when the system crashes and corrupts some configuration files. OS reinstall boot mode also resets some settings on your storage system, such as Internet protocol settings and the administrator password, to defaults.
- **Tech support.** Boots into a low-level diagnostic mode. Use the tech support boot mode only when a NETGEAR technical support representative instructs you to do so.
- **Volume read only.** Mounts a volume as read-only. Use this option when you are attempting to rescue data off a disk during a disaster recovery.
- **Memory test.** Performs a memory test. The memory test runs for eight hours. The current status and the pass or fail result is reported using the storage system LEDs, as described in the following table:

Figure 17. Memory Test Status

Memory Test State	Power LED	Disk 1 LED	Disk 2 LED	Backup LED
First hour	Off	Off	Off	Blinking
Second hour	Off	Off	Blinking	Off
Third hour	Off	Blinking	Off	Off
Forth hour	Off	Blinking	Blinking	Blinking
Fifth hour	On	Off	Off	Blinking
Sixth hour	On	Off	Blinking	Off
Seventh hour	On	Blinking	Off	Off
Eighth hour	On	Blinking	Blinking	Blinking
Result: fail	Blinking	Blinking	Blinking	Blinking
Result: pass	On	On	On	On

- **Test disk.** Performs an offline full disk test. This process can take four hours or more, depending on the size of your disks. Any problems are reported in the system logs. For more information about viewing the system logs, see the *ReadyNAS OS 6 Software Manual*, which is available at [netgear.com/support/product/ReadyNAS\\_OS\\_6](http://netgear.com/support/product/ReadyNAS_OS_6).

▶ **To access the boot menu:**

1. Power off your storage system.
2. Using a straightened paper clip, press and hold the **Reset** button.
3. Press the **Power** button.  
The system powers on.
4. Continue to press the **Reset** button until the **Power** button LED, USB and backup status LED, disk 1 LED, and disk 2 LED light.
5. Press the **Backup** button to scroll through boot mode options.  
The storage system shows the boot mode options using the LEDs, as described in the following table:

Boot Mode	Status Indicator				
	Description	Power LED	Disk 1 LED	Disk 2 LED	USB and Backup LED
Boot menu	All four LEDs light.	■	■	■	■
Normal	Power LED lights.	■	□	□	□
Factory default	Disk 1 LED lights.	□	■	□	□
OS reinstall	Disk 2 LED lights.	□	□	■	□
Tech support	USB and backup status LED lights.	□	□	□	■
Volume read only	Power LED and disk 1 LED light.	■	■	□	□
Memory test	Power LED and disk 2 LED light.	■	□	■	□
Test disk	Power LED and USB and backup status LED light.	■	□	□	■

Legend:

- On: ■
- Off: □

6. Press and release the **Reset** button to confirm your boot menu selection.  
The system boots in the selected boot mode.

This chapter provides an overview of the physical features of the ReadyNAS 214 and includes the following sections:

- *Front and Side Panels* on page 54
- *Drive Bays* on page 54
- *Rear Panel* on page 55
- *Status Information* on page 56
- *Power On and Shut Down* on page 57
- *Boot Menu* on page 58

## Front and Side Panels

The following figure shows the front and side panels of the ReadyNAS 214.

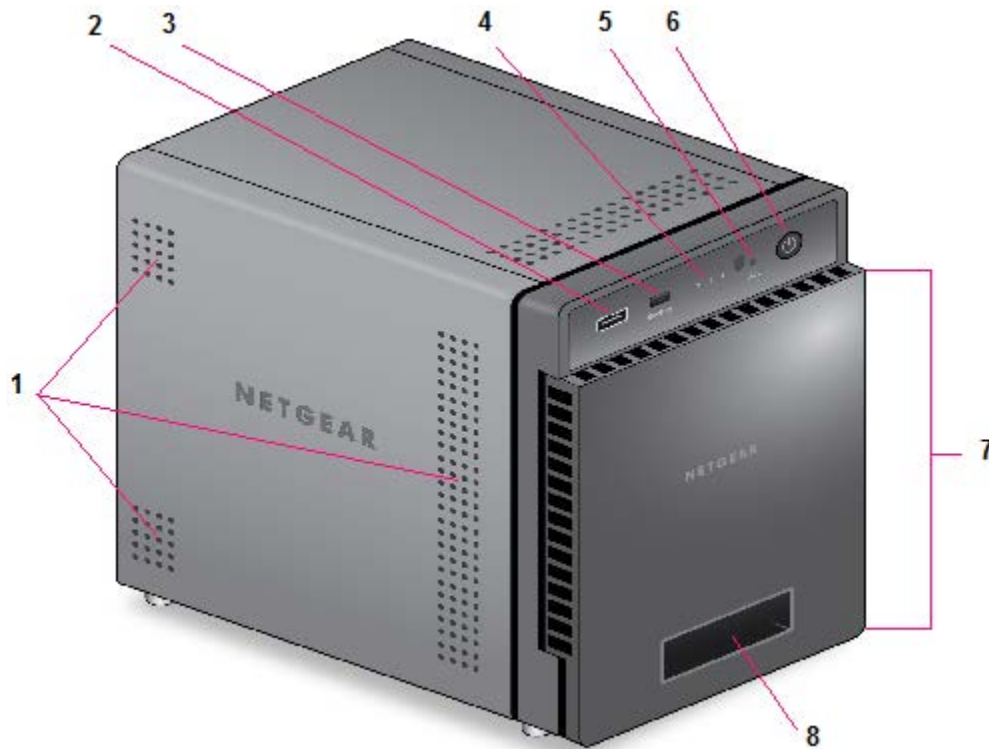

Figure 18. ReadyNAS 214 front and side panels

1. Exhaust vents
2. USB 2.0 port
3. Backup button and LED
4. Disk LEDs
5. Disk activity LED
6. Power button and LED
7. Drive bay door
8. Status display screen

## Drive Bays

The following figure shows the drive bays of the ReadyNAS 214.



Figure 19. ReadyNAS 214 drive bays

1. Drive bay door
2. Disk tray handle
3. Recessed disk tray handle lock
4. Disk tray release latch
5. Drive bays

## Rear Panel

The following figure shows the rear panel of the ReadyNAS 214.

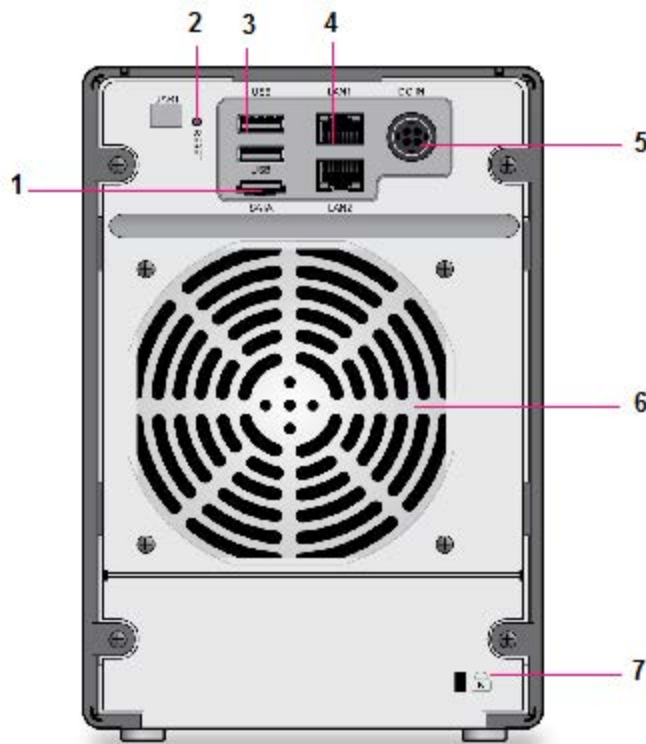

Figure 20. ReadyNAS 214 rear panel

1. eSATA port
2. Reset button
3. USB 3.0 ports
4. LAN ports with LED status indicators

---

**Note** The two LAN ports are equivalent. They can be used as two separate Ethernet connections, or can be configured as a single, bonded port with a 2 Gbps potential speed. For information about how to configure a bonded port, and the network configuration requirements needed to support 2 Gbps, see the *ReadyNAS OS 6 Software Manual*, which is available at [netgear.com/support/product/ReadyNAS\\_OS\\_6](http://netgear.com/support/product/ReadyNAS_OS_6).

---

5. Power cable socket
6. Exhaust fan
7. Kensington lock

## Status Information

You can obtain information about the status of your storage system by reviewing the indicators listed in the following table.



**Table 6. ReadyNAS 214 indicator descriptions**

Indicator	Description
Power button and LED	<p>Press this button to turn on the ReadyNAS. The LED indicates these states:</p> <ul style="list-style-type: none"> <li>• <b>On.</b> Powered on.</li> <li>• <b>Blinking.</b> Booting or shutting down.</li> <li>• <b>Off.</b> Powered off.</li> </ul>
Disk LEDs (1, 2, 3, 4)	<p>An LED on the top of the front panel is associated with each drive bay. LEDs are in numerical order from left to right. The disk LEDs indicate these states:</p> <ul style="list-style-type: none"> <li>• <b>On.</b> Power is on and the disk is operating normally.</li> <li>• <b>Blinking.</b> The disk was removed, failed, or is resynchronizing. See the display screen for details.</li> <li>• <b>Off.</b> The drive bay is empty.</li> </ul>
Disk activity LED	<p>The disk activity LED indicate these states:</p> <ul style="list-style-type: none"> <li>• <b>Blinking.</b> A disk is being accessed.</li> <li>• <b>Off.</b> All disks are idle.</li> </ul>
Rear panel Ethernet port LEDs	<p>Two LED status indicators are built into each port, one off or green and one showing three states: off, amber, or green. They indicate port speed and activity as follows:</p> <ul style="list-style-type: none"> <li>• <b>Green, green.</b> 1000 Mbps connection speed, no activity.</li> <li>• <b>Green blinking, green.</b> 1000 Mbps connection speed, activity.</li> <li>• <b>Green, amber.</b> 100 Mbps connection speed, no activity.</li> <li>• <b>Green blinking, amber.</b> 100 Mbps connection speed, activity.</li> <li>• <b>Green on, off.</b> 10 Mbps connection speed, no activity.</li> <li>• <b>Green blinking, off.</b> 10 Mbps connection speed, activity.</li> <li>• <b>Off, off.</b> No connection.</li> </ul>
Status display screen	<p>Displays messages about the status of your storage system. Note that the status display screen goes to sleep to prevent burn-in. To wake it, press the <b>Power</b> button once. If the storage system reports an abnormal operation or error, the status display screen stays on.</p>

## Power On and Shut Down

This section describes how to power on and shut down your system. If you must shut down the system, use one of the preferred shutdown methods whenever possible.

### Power On

When you connect the system to a power supply or the system recovers from a power outage, the system returns to its last state:

- If the system was powered on, the system automatically powers on again when the power supply is connected or power is restored.
- If the system was powered off, the system remains off when the power supply is connected or power is restored.  
In this situation, press the **Power** button on the front panel of the system to power on the system.

### Preferred Shutdown

You can gracefully shut down your system by using the **Power** button or the ReadyNAS local admin page.

For information about how to gracefully shut down your system using the ReadyNAS local admin page, see the *ReadyNAS OS 6 Software Manual*, which is available at [netgear.com/support/product/ReadyNAS\\_OS\\_6](http://netgear.com/support/product/ReadyNAS_OS_6).

#### ▶ To gracefully shut down your system using the Power button:

1. If the status display screen is not lit, do the following:
  - a. Press the **Power** button.  
The status display screen wakes.
  - b. Press the **Power** button a second time.  
Instructions for graceful shutdown display on the status display screen.
  - c. Press the **Power** button a third time.  
The system shuts down gracefully.
2. If the status display screen is lit, do the following:
  - a. Press the **Power** button.  
Instructions for graceful shutdown display on the status display screen.
  - b. Press the **Power** button again.  
The system shuts down gracefully.

### Forced Shutdown

Perform a forced shutdown only if the storage system is not responding.

#### ▶ To perform a forced shutdown:

- Unplug the system from the power supply.

### Boot Menu

Use the boot menu to restart or troubleshoot your ReadyNAS storage system. Your storage system has the following boot modes:

## ReadyNAS OS 6 Desktop Storage Systems

- **Normal.** Initiates a normal boot process, just like booting using the **Power** button.
- **Factory default.** Initiates a short disk test that takes approximately 5 minutes. After the disk test, a 10-minute time-out period begins, during which all LEDs blink simultaneously.



### **WARNING:**

The factory default reboot process resets the storage system to factory settings, erases all data, resets all defaults, and reformats the disk to X-RAID.

- If you want to cancel the factory default process, power off the storage system before the 10-minute time-out ends. The system powers down safely without causing any data loss.
- If you want to reset the system to factory default settings, do not power off your system. After the 10-minute time-out period, the factory default process begins.

**Tip** To start the factory default process immediately, press the **Backup** button during the 10-minute time-out period.

- **OS reinstall.** Reinstalls the firmware from the internal flash to the disks. Use the OS reinstall boot mode when the system crashes and corrupts some configuration files. OS reinstall boot mode also resets some settings on your storage system, such as Internet protocol settings and the administrator password, to defaults.
- **Tech support.** Boots into a low-level diagnostic mode. Use the tech support boot mode only when a NETGEAR technical support representative instructs you to do so.
- **Volume read only.** Mounts a volume as read-only. Use this option when you are attempting to rescue data off a disk during a disaster recovery.
- **Memory test.** Performs a memory test. The pass or fail result is reported on the status display screen.
- **Test disk.** Performs an offline full disk test. This process can take four hours or more, depending on the size of your disks. Any problems are reported in the system logs. For more information about viewing the system logs, see the *ReadyNAS OS 6 Software Manual*, which is available at [netgear.com/support/product/ReadyNAS\\_OS\\_6](http://netgear.com/support/product/ReadyNAS_OS_6).

### ▶ **To access the boot menu:**

1. Power off your storage system.
2. Using a straightened paper clip, press and hold the **Reset** button.
3. Press the **Power** button.  
The system powers on.
4. Continue to press the **Reset** button until the status display screen shows a boot menu message.
5. Press the **Backup** button to scroll through boot mode options.  
The status display screen shows the current boot mode option.
6. When the status display screen shows the boot mode that you need, press and release the **Reset** button to confirm your boot menu selection.  
The system boots in the selected boot mode.

This chapter provides an overview of the physical features of the ReadyNAS 312 and includes the following sections:

- *Front and Side Panels* on page 61
- *Drive Bays* on page 61
- *Rear Panel* on page 62
- *Status Information* on page 63
- *Power On and Shut Down* on page 64
- *Boot Menu* on page 65

## Front and Side Panels

The following figure shows the front and side panels of the ReadyNAS 312.

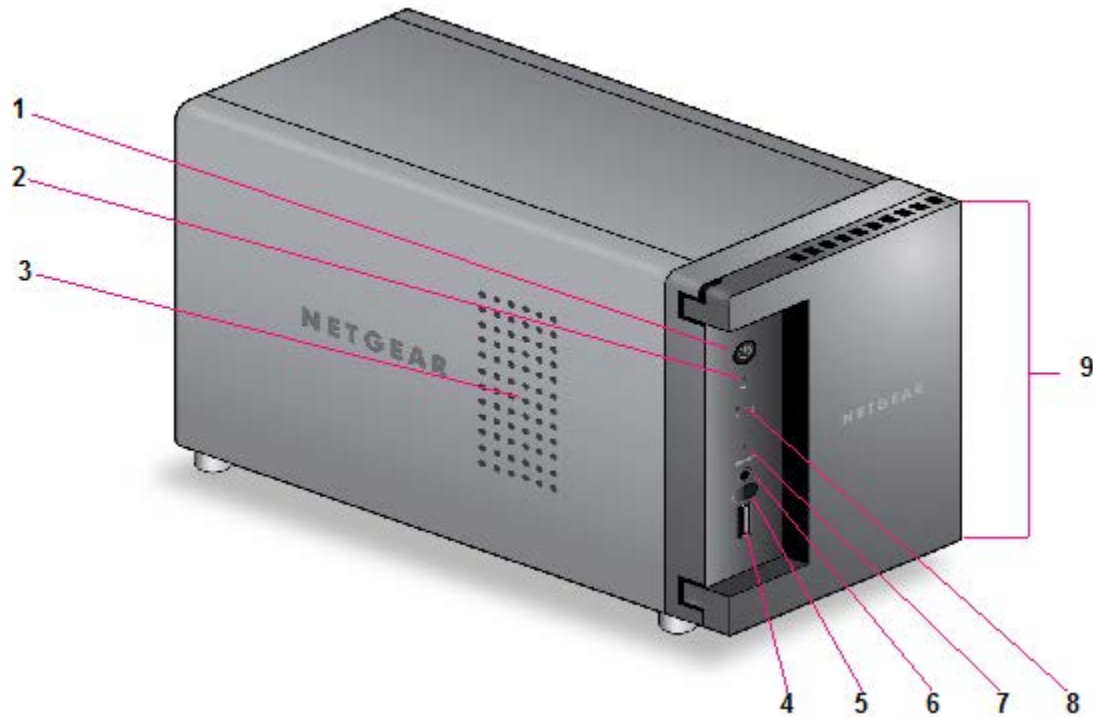

Figure 21. ReadyNAS 312 front and side panels

1. Power button and LED
2. Disk activity LED
3. Exhaust vent
4. USB 2.0 port
5. Infrared remote receiver
6. Backup button
7. USB and Backup status LED
8. Disk 1 and Disk 2 LEDs
9. Drive bay door

## Drive Bays

The following figure shows the drive bays of the ReadyNAS 312.

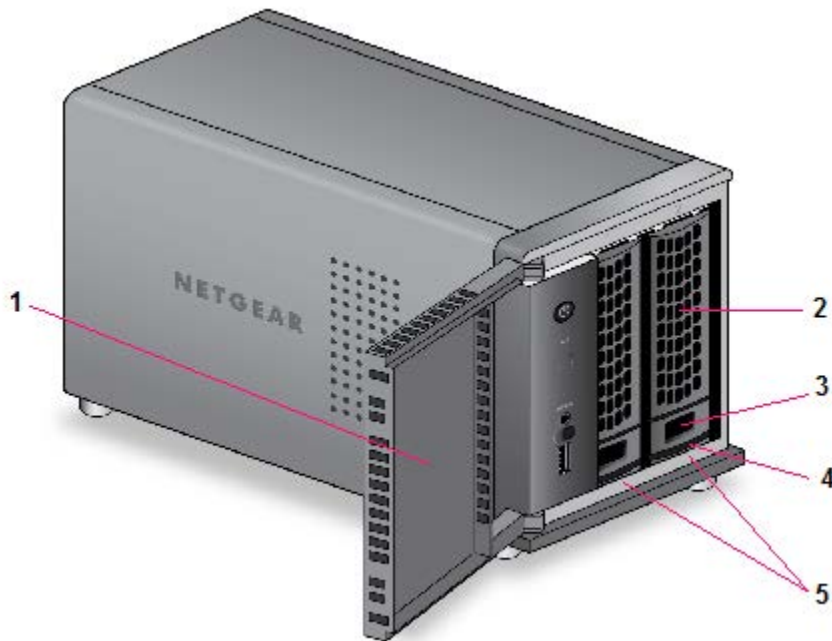

Figure 22. ReadyNAS 312 drive bays

1. Drive bay door
2. Disk tray handle
3. Recessed disk tray handle lock
4. Disk tray release latch
5. Drive bays

## Rear Panel

The following figure shows the rear panel of the ReadyNAS 312.

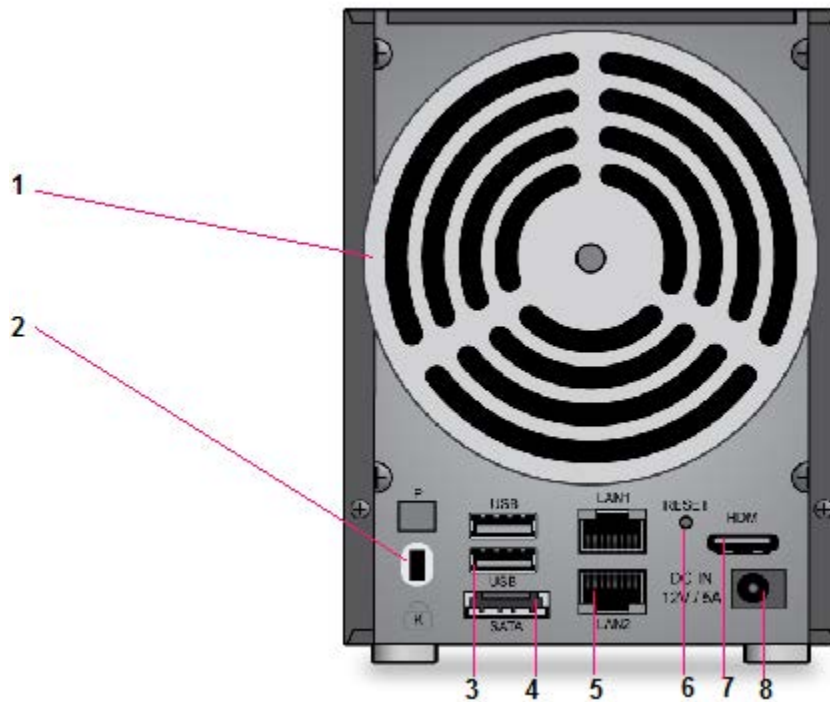

Figure 23. ReadyNAS 312 rear panel

1. Exhaust fan
2. Kensington lock
3. USB 3.0 ports
4. eSATA port
5. LAN ports with LED status indicators
6. Reset button
7. HDMI port (currently not supported)
8. Power adapter socket

## Status Information

You can obtain information about the status of your storage system by reviewing the indicators listed in the following table.

**Table 7. ReadyNAS 312 indicator descriptions**

Indicator	Description
Power button and LED	<p>Press this button to turn on the ReadyNAS. The LED has these states:</p> <ul style="list-style-type: none"> <li>• <b>On.</b> Powered on.</li> <li>• <b>Blinking.</b> Booting or shutting down.</li> <li>• <b>Off.</b> Powered off.</li> </ul>
Disk LEDs (1, 2)	<p>An LED on the front panel of the storage system is associated with each drive bay The disk LEDs have these states:</p> <ul style="list-style-type: none"> <li>• <b>On.</b> Power is on and the disk is operating normally.</li> <li>• <b>Blinking.</b> The disk was removed, failed, or is resynchronizing.</li> <li>• <b>Off.</b> The drive bay is empty.</li> </ul>
Disk activity LED	<p>The disk activity LED has these states:</p> <ul style="list-style-type: none"> <li>• <b>On.</b> At least one disk is present.</li> <li>• <b>Blinking.</b> A disk is active.</li> <li>• <b>Off.</b> All disks are idle.</li> </ul>
Rear panel Ethernet port LEDs	<p>Two LED status indicators are built into this port, one green and one amber. They indicate port speed and activity as follows:</p> <ul style="list-style-type: none"> <li>• <b>Green on, amber off.</b> 1000 Mbps connection speed, no activity.</li> <li>• <b>Green blinking, amber off.</b> 1000 Mbps connection speed, activity.</li> <li>• <b>Green off, amber on.</b> 10 Mbps or 100 Mbps connection speed, no activity.</li> <li>• <b>Green off, amber blinking.</b> 10 Mbps or 100 Mbps connection speed, activity.</li> <li>• <b>Green off, amber off.</b> No connection.</li> </ul>

## Power On and Shut Down

This section describes how to power on and shut down your system. If you need to shut down the system, use one of the preferred shutdown methods whenever possible.

### Power On

When you connect the system to a power supply or the system recovers from a power outage, the following occurs:



- The system automatically powers on if you enabled the Wake on LAN (WoL) feature or scheduled the system to automatically power on or off.
- The system returns to its last state if the Wake on LAN (WoL) feature is disabled and you did not schedule the system to automatically power on or off:
  - If the system was powered on, the system automatically powers on again when the power supply is connected or power is restored.
  - If the system was powered off, the system remains off when the power supply is connected or power is restored.In this situation, press the **Power** button on the front panel of the system to power on the system.

### Preferred Shutdown

You can gracefully shut down your system by using the **Power** button or the ReadyNAS local admin page.

For information about how to gracefully shut down your system using the ReadyNAS local admin page, see the *ReadyNAS OS 6 Software Manual*, which is available at [netgear.com/support/product/ReadyNAS\\_OS\\_6](http://netgear.com/support/product/ReadyNAS_OS_6).

#### ▶ To gracefully shut down your system using the Power button:

1. Press the **Power** button.  
The Power LED blinks, prompting you to confirm the shutdown.
2. Press the **Power** button again.  
The system shuts down gracefully.

### Forced Shutdown

Perform a forced shutdown only if the storage system is not responding.

#### ▶ To perform a forced shutdown:

- Press and hold the **Power** button for five seconds.  
The LEDs blink quickly and simultaneously to warn that power will be cut off forcibly.  
The system shuts down.

### Boot Menu

Use the boot menu to restart or troubleshoot your ReadyNAS storage system. Your storage system has the following boot modes:

- **Normal.** Initiates a normal boot process, just like booting using the Power button.
- **Factory default.** Initiates a short disk test that takes approximately 5 minutes. After the disk test, a 10-minute time-out period begins, during which all LEDs blink simultaneously.



### WARNING:

The factory default reboot process resets the storage system to factory settings, erases all data, resets all defaults, and reformats the disk to X-RAID.

- If you want to cancel the factory default process, power off the storage system before the 10-minute time-out ends. The system powers down safely without causing any data loss.
- If you want to reset the system to factory default settings, do not power off your system. After the 10-minute time-out period, the factory default process begins.

**Tip** To start the factory default process immediately, press the **Backup** button during the 10-minute time-out period.

- **OS reinstall.** Reinstalls the firmware from the internal flash to the disks. Use the OS reinstall boot mode when the system crashes and corrupts some configuration files. OS reinstall boot mode also resets some settings on your storage system, such as Internet protocol settings and the administrator password, to defaults.
- **Tech support.** Boots into a low-level diagnostic mode. Use the tech support boot mode only when a NETGEAR technical support representative instructs you to do so.
- **Volume read only.** Mounts a volume as read-only. Use this option when you are attempting to rescue data off a disk during a disaster recovery.
- **Memory test.** Performs a memory test. The pass or fail result is reported using the storage system's LEDs. Contact a NETGEAR technical support representative to interpret memory test results.
- **Test disk.** Performs an offline full disk test. This process can take four hours or more, depending on the size of your disks. Any problems are reported in the system logs. For more information about viewing the system logs, see the *ReadyNAS OS 6 Software Manual*, which is available at [netgear.com/support/product/ReadyNAS\\_OS\\_6](http://netgear.com/support/product/ReadyNAS_OS_6).

### ▶ To access the boot menu:

1. Power off your storage system.
2. Using a straightened paper clip, press and hold the **Reset** button.
3. Press the **Power** button.  
The system powers on.
4. Continue to press the **Reset** button until the Power button LED, USB and backup status LED, disk 1 LED, and disk 2 LED light.
5. Press the **Backup** button to scroll through boot mode options.  
The storage system shows the boot mode options using the LEDs, as described in the following table:

## ReadyNAS OS 6 Desktop Storage Systems

Boot Mode	Status Indicator				
	Description	Power LED	Disk 1 LED	Disk 2 LED	USB and Backup LED
Boot menu	All four LEDs light.	■	■	■	■
Normal	Power LED lights.	■	□	□	□
Factory default	Disk 1 LED lights.	□	■	□	□
OS reinstall	Disk 2 LED lights.	□	□	■	□
Tech support	USB and backup status LED lights.	□	□	□	■
Volume read only	Power LED and disk 1 LED light.	■	■	□	□
Memory test	Power LED and disk 2 LED light.	■	□	■	□
Test disk	Power LED and USB and backup status LED light.	■	□	□	■

Legend:

- On: ■
- Off: □

6. Press and release the **Reset** button to confirm your boot menu selection. The system boots in the selected boot mode.

This chapter provides an overview of the physical features of the ReadyNAS 314 and includes the following sections:

- *Front and Side Panels* on page 69
- *Drive Bays* on page 69
- *Rear Panel* on page 70
- *Status Information* on page 71
- *Power On and Shut Down* on page 72
- *Boot Menu* on page 74

## Front and Side Panels

The following figure shows the front and side panels of the ReadyNAS 314.

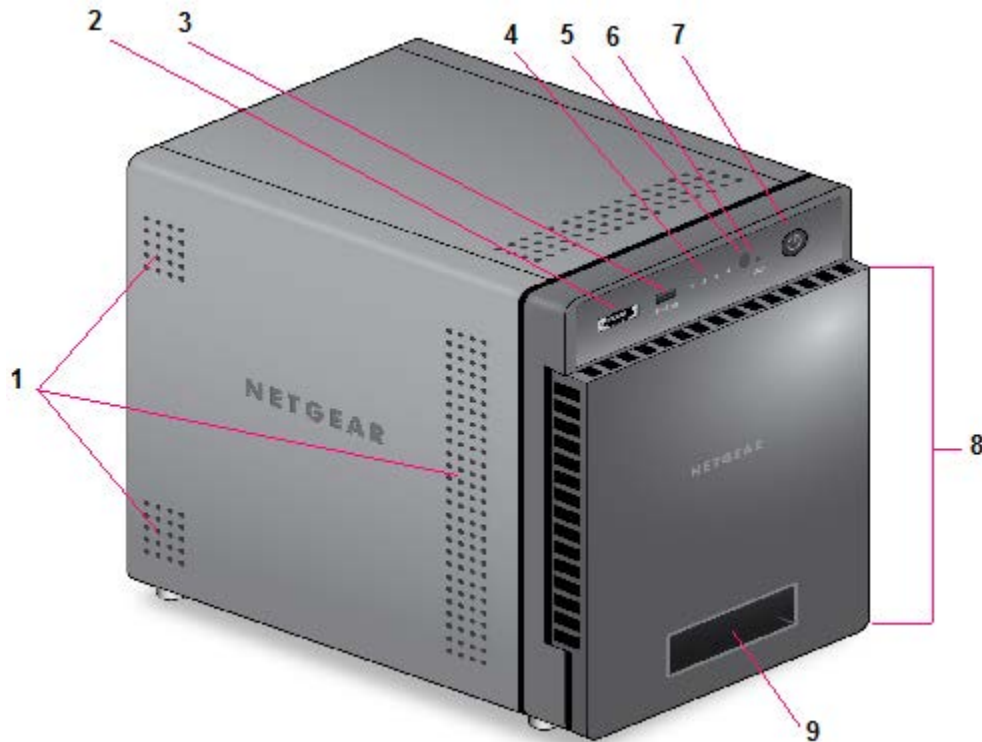

Figure 24. ReadyNAS 314 front and side panels

1. Exhaust vents
2. Shared USB 2.0 and eSATA port
3. Backup button and LED
4. Disk LEDs
5. Infrared remote receiver
6. Disk activity LED
7. Power button and LED
8. Drive bay door
9. Status display screen

## Drive Bays

The following figure shows the drive bays of the ReadyNAS 314.



Figure 25. ReadyNAS 314 drive bays

1. Drive bay door
2. Disk tray handle
3. Recessed disk tray handle lock
4. Disk tray release latch
5. Drive bays

## Rear Panel

The following figure shows the rear panel of the ReadyNAS 314.

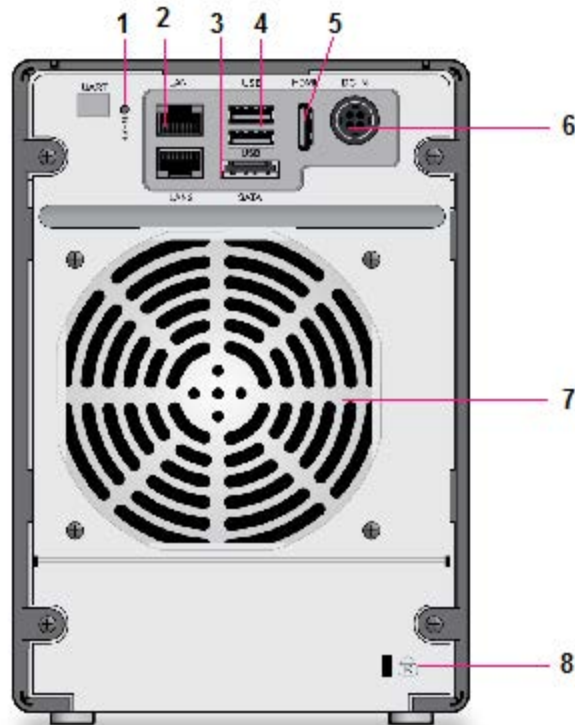

Figure 26. ReadyNAS 314 rear panel

1. Reset button
2. LAN ports with LED status indicators
3. eSATA port
4. USB 3.0 ports
5. HDMI port (currently not supported)
6. Power cable socket
7. Exhaust fan
8. Kensington lock

## Status Information

You can obtain information about the status of your storage system by reviewing the indicators listed in the following table.

**Table 8. ReadyNAS 314 indicator descriptions**

Indicator	Description
Power button and LED	<p>Press this button to turn on the ReadyNAS. The LED indicates these states:</p> <ul style="list-style-type: none"> <li>• <b>On.</b> Powered on.</li> <li>• <b>Blinking.</b> Booting or shutting down.</li> <li>• <b>Off.</b> Powered off.</li> </ul>
Disk LEDs (1, 2, 3, 4)	<p>An LED on the top of the front panel is associated with each drive bay. LEDs are in numerical order from left to right. The disk LEDs indicate these states:</p> <ul style="list-style-type: none"> <li>• <b>On.</b> Power is on and the disk is operating normally.</li> <li>• <b>Blinking.</b> The disk was removed, failed, or is resynchronizing. See the display screen for details.</li> <li>• <b>Off.</b> The drive bay is empty.</li> </ul>
Disk activity LED	<p>The disk activity LED has these states:</p> <ul style="list-style-type: none"> <li>• <b>On.</b> At least one disk is present.</li> <li>• <b>Blinking.</b> A disk is active.</li> <li>• <b>Off.</b> All disks are idle.</li> </ul>
Rear panel Ethernet port LEDs	<p>Two LED status indicators are built into this port, one green and one amber. They indicate port speed and activity as follows:</p> <ul style="list-style-type: none"> <li>• <b>Green on, amber off.</b> 1000 Mbps connection speed, no activity.</li> <li>• <b>Green blinking, amber off.</b> 1000 Mbps connection speed, activity.</li> <li>• <b>Green off, amber on.</b> 10 Mbps or 100 Mbps connection speed, no activity.</li> <li>• <b>Green off, amber blinking.</b> 10 Mbps or 100 Mbps connection speed, activity.</li> <li>• <b>Green off, amber off.</b> No connection.</li> </ul>
Status display screen	<p>Displays messages about the status of your storage system. Note that the status display screen goes to sleep to prevent burn-in. To wake it, press the <b>Power</b> button once. If the storage system reports an abnormal operation or error, the status display screen stays on.</p>

## Power On and Shut Down

This section describes how to power on and shut down your system. If you must shut down the system, use one of the preferred shutdown methods whenever possible.



### Power On

When you connect the system to a power supply or the system recovers from a power outage, the following occurs:

- The system automatically powers on if you enabled the Wake on LAN (WoL) feature or scheduled the system to automatically power on or off.
- The system returns to its last state if the Wake on LAN (WoL) feature is disabled and you did not schedule the system to automatically power on or off:
  - If the system was powered on, the system automatically powers on again when the power supply is connected or power is restored.
  - If the system was powered off, the system remains off when the power supply is connected or power is restored.In this situation, press the **Power** button on the front panel of the system to power on the system.

### Preferred Shutdown

You can gracefully shut down your system by using the **Power** button or the ReadyNAS local admin page.

For information about how to gracefully shut down your system using the ReadyNAS local admin page, see the *ReadyNAS OS 6 Software Manual*, which is available at [netgear.com/support/product/ReadyNAS\\_OS\\_6](http://netgear.com/support/product/ReadyNAS_OS_6).

#### ► To gracefully shut down your system using the Power button:

1. If the status display screen is not lit, do the following:
  - a. Press the **Power** button.  
The status display screen wakes.
  - b. Press the **Power** button a second time.  
Instructions for graceful shutdown display on the status display screen.
  - c. Press the **Power** button a third time.  
The system shuts down gracefully.
2. If the status display screen is lit, do the following:
  - a. Press the **Power** button.  
Instructions for graceful shutdown display on the status display screen.
  - b. Press the **Power** button again.  
The system shuts down gracefully.

### Forced Shutdown

Perform a forced shutdown only if the storage system is not responding.

#### ► To perform a forced shutdown:

- Press and hold the **Power** button on the front panel of the system for five seconds.  
The LEDs blink quickly and simultaneously to warn that power will be cut off forcibly.

The system shuts down.

## Boot Menu

Use the boot menu to restart or troubleshoot your ReadyNAS storage system. Your storage system has the following boot modes:

- **Normal.** Initiates a normal boot process, just like booting using the **Power** button.
- **Factory default.** Initiates a short disk test that takes approximately 5 minutes. After the disk test, a 10-minute time-out period begins, during which all LEDs blink simultaneously.



### **WARNING:**

**The factory default reboot process resets the storage system to factory settings, erases all data, resets all defaults, and reformats the disk to X-RAID.**

- If you want to cancel the factory default process, power off the storage system before the 10-minute time-out ends. The system powers down safely without causing any data loss.
- If you want to reset the system to factory default settings, do not power off your system. After the 10-minute time-out period, the factory default process begins.

**Tip** To start the factory default process immediately, press the **Backup** button during the 10-minute time-out period.

- **OS reinstall.** Reinstalls the firmware from the internal flash to the disks. Use the OS reinstall boot mode when the system crashes and corrupts some configuration files. OS reinstall boot mode also resets some settings on your storage system, such as Internet protocol settings and the administrator password, to defaults.
- **Tech support.** Boots into a low-level diagnostic mode. Use the tech support boot mode only when a NETGEAR technical support representative instructs you to do so.
- **Volume read only.** Mounts a volume as read-only. Use this option when you are attempting to rescue data off a disk during a disaster recovery.
- **Memory test.** Performs a memory test. The pass or fail result is reported on the status display screen.
- **Test disk.** Performs an offline full disk test. This process can take four hours or more, depending on the size of your disks. Any problems are reported in the system logs. For more information about viewing the system logs, see the *ReadyNAS OS 6 Software Manual*, which is available at [netgear.com/support/product/ReadyNAS\\_OS\\_6](http://netgear.com/support/product/ReadyNAS_OS_6).

### ▶ **To access the boot menu:**

1. Power off your storage system.
2. Using a straightened paper clip, press and hold the **Reset** button.
3. Press the **Power** button.  
The systems powers on.

## ReadyNAS OS 6 Desktop Storage Systems

4. Continue to press the **Reset** button until the status display screen shows a boot menu message.
5. Press the **Backup** button to scroll through boot mode options.  
The status display screen shows the current boot mode option.
6. When the status display screen shows the boot mode that you need, press and release the **Reset** button to confirm your boot menu selection.  
The system boots in the selected boot mode.

This chapter provides an overview of the physical features of the ReadyNAS 316 and includes the following sections:

- *Front and Side Panels* on page 77
- *Drive Bays* on page 77
- *Rear Panel* on page 78
- *Status Information* on page 79
- *Power On and Shut Down* on page 80
- *Boot Menu* on page 81

## Front and Side Panels

The following figure shows the front and side panels of the ReadyNAS 316.



Figure 27. ReadyNAS 316 front and side panels

1. Status and menu display screen
2. Infrared remote receiver
3. Drive bay door
4. Touch pad and backlight
5. OK button

## Drive Bays

The following figure shows the drive bays of the ReadyNAS 316.

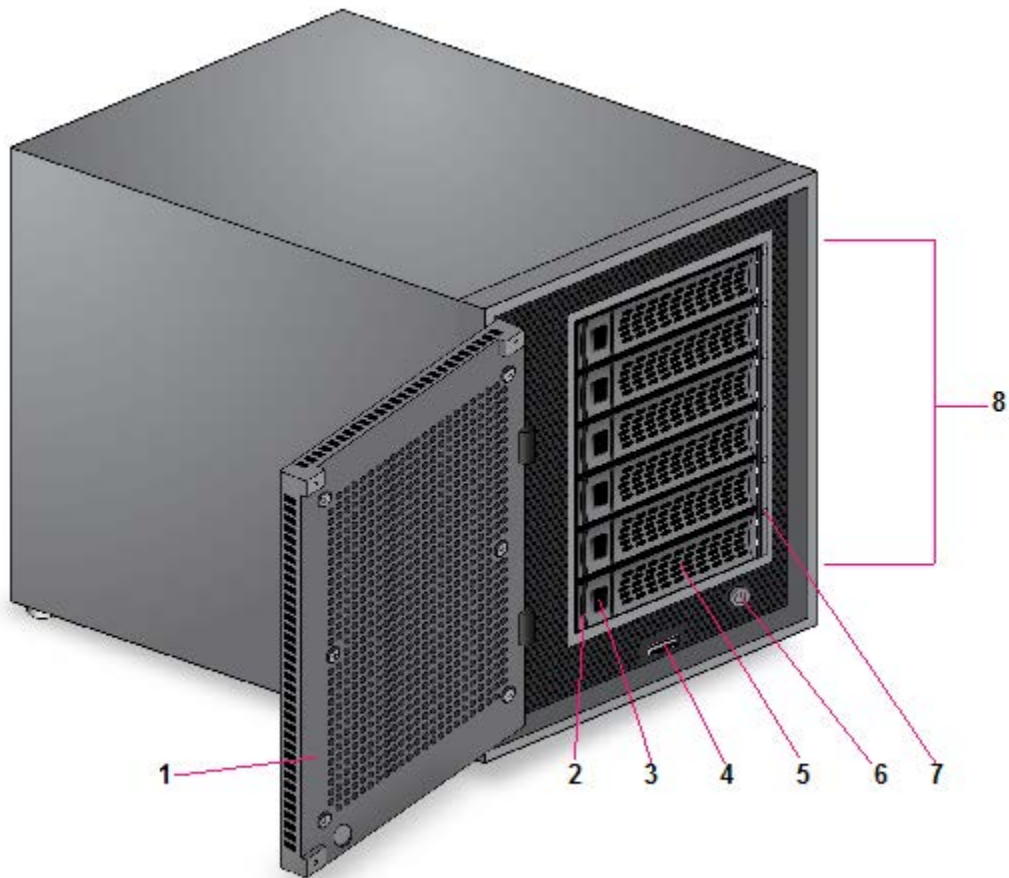

Figure 28. ReadyNAS 316 drive bays

1. Drive bay door
2. Disk tray release latch
3. Recessed disk tray handle lock
4. USB 2.0 port
5. Disk tray handle
6. Power button
7. Disk LED
8. Drive bays

## Rear Panel

The following figure shows the rear panel of the ReadyNAS 316.

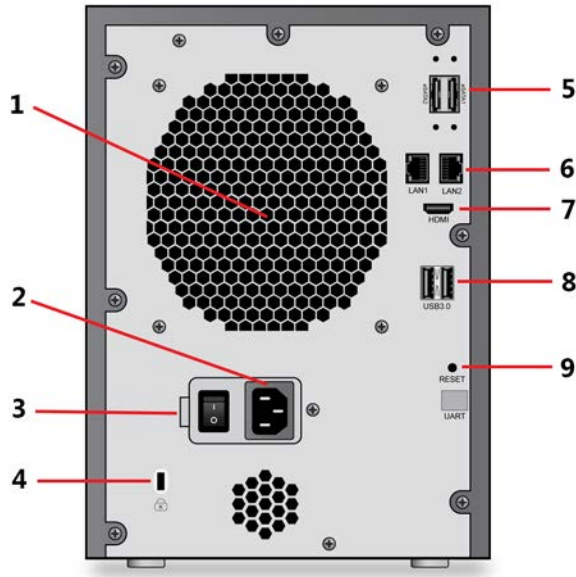

Figure 29. ReadyNAS 316 rear panel

1. Exhaust fan
2. Power cable socket
3. Power switch
4. Kensington lock
5. eSATA ports
6. LAN ports with LED status indicators
7. HDMI port (currently not supported)
8. USB 3.0 ports
9. Reset button

## Status Information

You can obtain information about the status of your storage system by reviewing the indicators listed in the following table.

**Table 9. ReadyNAS 316 indicator descriptions**

Indicator	Description
Disk LEDs	<p>A disk LED next to each drive bay indicates the status of the disk inside. The disk LEDs indicate these states:</p> <ul style="list-style-type: none"> <li>• <b>Solid blue.</b> Power is on and the disk is operating normally.</li> <li>• <b>Blinking blue.</b> The disk is active.</li> <li>• <b>Solid red.</b> The disk was removed, failed, or is resynchronizing. See the display screen for details.</li> <li>• <b>Off.</b> No disk is present.</li> </ul>
Rear panel Ethernet port LEDs	<p>Two LED status indicators are built into this port, one green and one amber. They indicate port speed and activity as follows:</p> <ul style="list-style-type: none"> <li>• <b>Green on, amber off.</b> 1000 Mbps connection speed, no activity.</li> <li>• <b>Green blinking, amber off.</b> 1000 Mbps connection speed, activity.</li> <li>• <b>Green off, amber on.</b> 10 Mbps or 100 Mbps connection speed, no activity.</li> <li>• <b>Green off, amber blinking.</b> 10 Mbps or 100 Mbps connection speed, activity.</li> <li>• <b>Green off, amber off.</b> No connection.</li> </ul>
Status display screen	<p>Displays messages about the status of your storage system. Note that the status display screen goes to sleep to prevent burn-in. To wake the status display screen, activate the proximity sensor, press the touch pad, press the <b>OK</b> button, or press the <b>Power</b> button once. If the storage system reports an abnormal operation or error, the status display screen stays on.</p>

## Power On and Shut Down

This section describes how to power on and shut down your system. If you must shut down the system, use one of the preferred shutdown methods whenever possible.

### Power On

When you connect the system to a power supply and the **Power** switch is in the On position or the system recovers from a power outage and the **Power** switch is in the On position, the following occurs:

- The system automatically powers on if you enabled the Wake on LAN (WoL) feature or scheduled the system to automatically power on or off.
- The system returns to its last state if the Wake on LAN (WoL) feature is disabled and you did not schedule the system to automatically power on or off:



- If the system was powered on, the system automatically powers on again when the power supply is connected or power is restored.
- If the system was powered off, the system remains off when the power supply is connected or power is restored.  
In this situation, press the **Power** button on the front panel of the system to power on the system.

## Preferred Shutdown

You can gracefully shut down your system by using the **Power** button or the ReadyNAS local admin page.

For information about how to gracefully shut down your system using the ReadyNAS local admin page, see the *ReadyNAS OS 6 Software Manual*, which is available at [netgear.com/support/product/ReadyNAS\\_OS\\_6](http://netgear.com/support/product/ReadyNAS_OS_6).

### ► To gracefully shut down your system using the Power button:

1. If the status display screen is not lit, do the following:
  - a. Press the **Power** button on the front panel of the system.  
The status display screen wakes.
  - b. Press the **Power** button a second time.  
Instructions for graceful shutdown display on the status display screen.
  - c. Press the **Power** button a third time.  
The system shuts down gracefully.
2. If the status display screen is lit, do the following:
  - a. Press the **Power** button on the front panel of the system.  
Instructions for graceful shutdown display on the status display screen.
  - b. Press the **Power** button again.  
The system shuts down gracefully.

## Forced Shutdown

Perform a forced shutdown only if the storage system is not responding.

### ► To perform a forced shutdown:

- Press and hold the **Power** button on the front panel of the system for five seconds.  
The LEDs blink quickly and simultaneously to warn that power will be cut off forcibly.

The system shuts down.

## Boot Menu

Use the boot menu to restart or troubleshoot your ReadyNAS storage system. Your storage system has the following boot modes:

## ReadyNAS OS 6 Desktop Storage Systems

- **Normal.** Initiates a normal boot process, just like booting using the **Power** button.
- **Factory default.** Initiates a short disk test that takes approximately 2 minutes. After the disk test, a 10-minute time-out period begins, during which all LEDs blink simultaneously.



### **WARNING:**

**The factory default reboot process resets the storage system to factory settings, erases all data, resets all defaults, and reformats the disk to X-RAID.**

- If you want to cancel the factory default process, power off the storage system before the 10-minute time-out ends. The system powers down safely without causing any data loss.
- If you want to reset the system to factory default settings, do not power off your system. After the 10-minute time-out period, the factory default process begins.

**Tip** To start the factory default process immediately, press the **OK** button during the 10-minute time-out period.

- **OS reinstall.** Reinstalls the firmware from the internal flash to the disks. Use the OS reinstall boot mode when the system crashes and corrupts some configuration files. OS reinstall boot mode also resets some settings on your storage system, such as Internet protocol settings and the administrator password, to defaults.
- **Tech support.** Boots into a low-level diagnostic mode. Use the tech support boot mode only when a NETGEAR technical support representative instructs you to do so.
- **Volume read only.** Mounts a volume as read-only. Use this option when you are attempting to rescue data off a disk during a disaster recovery.
- **Memory test.** Performs a memory test. The pass or fail result is reported on the status display screen.
- **Test disk.** Performs an offline full disk test. This process can take four hours or more, depending on the size of your disks. Any problems are reported in the system logs. For more information about viewing the system logs, see the *ReadyNAS OS 6 Software Manual*, which is available at [netgear.com/support/product/ReadyNAS\\_OS\\_6](http://netgear.com/support/product/ReadyNAS_OS_6).

### ► **To access the boot menu:**

1. Power off your storage system.
2. Using a straightened paper clip, press and hold the **Reset** button.
3. Press the **Power** button on the front panel of the system.  
The system powers on.
4. Continue to press the **Reset** button until the status display screen shows a boot menu message.
5. Use the arrows on the touch pad to scroll through boot mode options.  
The status display screen shows the current boot mode option.
6. When the status display screen shows the boot mode that you need, press the **OK** button to confirm your boot menu selection.  
The system boots in the selected boot mode.

This chapter provides an overview of the physical features of the ReadyNAS 422 and includes the following sections:

- *Front and Side Panels* on page 84
- *Drive Bays* on page 85
- *Rear Panel* on page 86
- *Status Information* on page 87
- *Power On and Shut Down* on page 87
- *Boot Menu* on page 89

## Front and Side Panels

The following figure shows the front and side panels of the ReadyNAS 422.

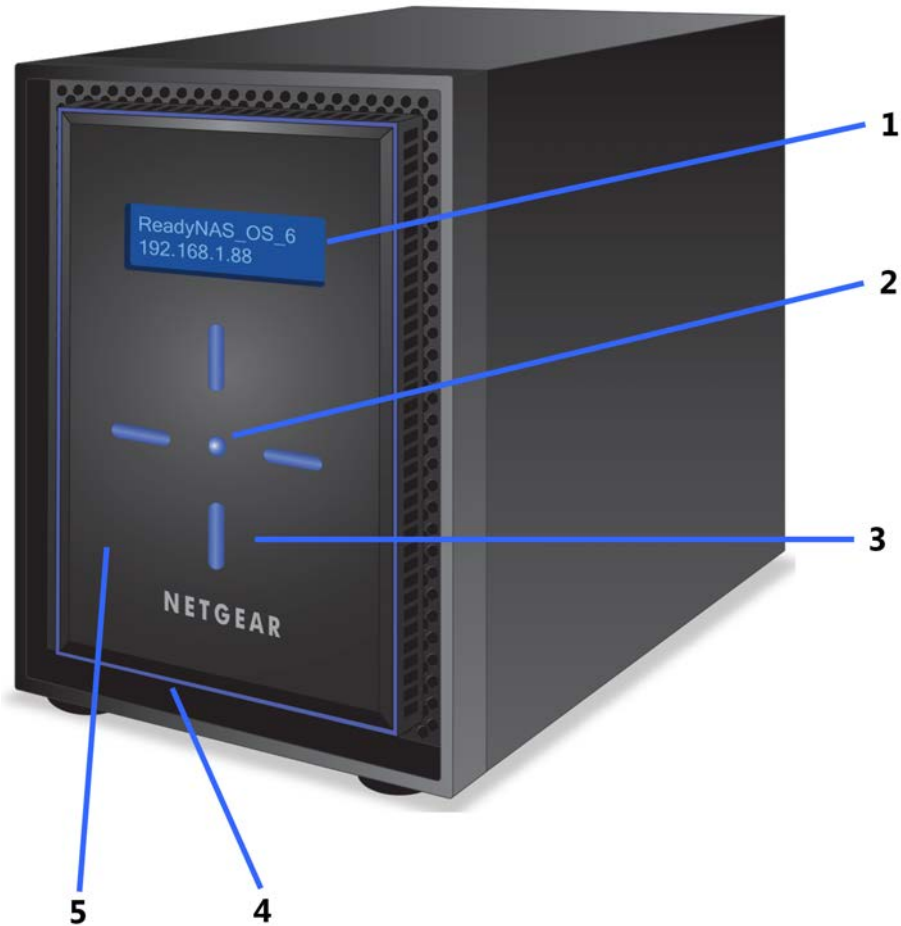

Figure 30. ReadyNAS 422 front and side panels

1. Status and menu display screen
2. OK button
3. Four buttons (Up, Down, Left, Right) and backlights
4. USB 3.0 port
5. Drive bay door

## Drive Bays

The following figure shows the drive bays of ReadyNAS 422.

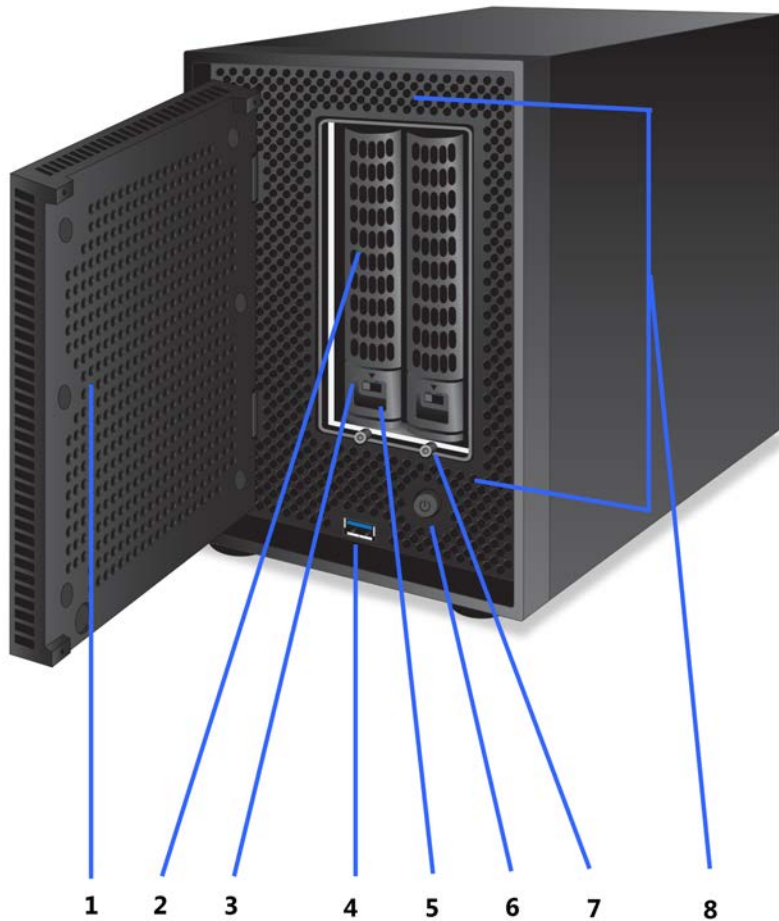

Figure 31. ReadyNAS 422 drive bays

1. Drive bay door
2. Disk tray handle
3. Disk tray release latch
4. USB 3.0 port
5. Recessed disk tray handle lock
6. Power button
7. Disk LED
8. Drive bays

## Rear Panel

The following figure shows the rear panel of the ReadyNAS 422.

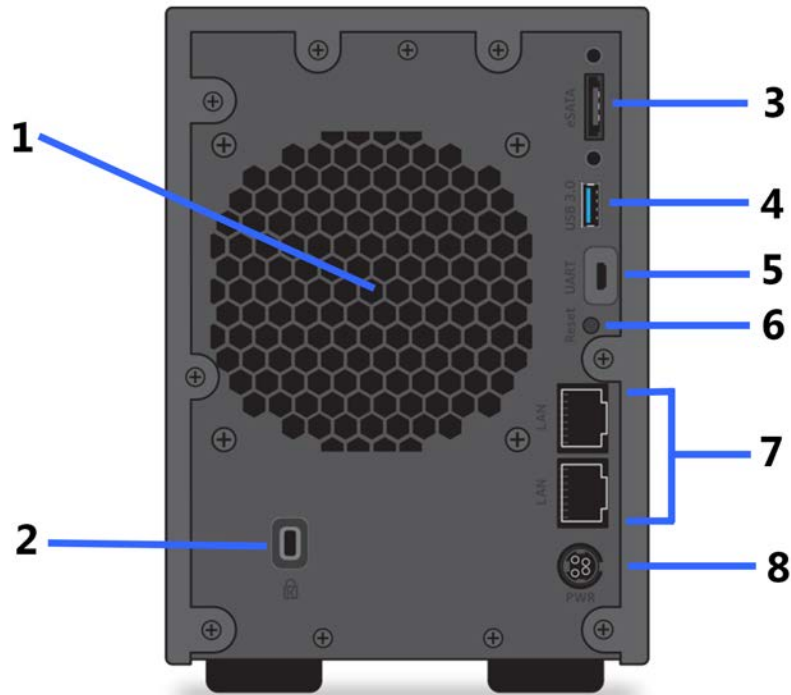

Figure 32. Rear panel ReadyNAS 422

1. Exhaust fan
2. Kensington lock
3. eSATA port
4. USB 3.0 port
5. Micro USB console connector (marked as UART)
6. Reset button
7. 1 GbE LAN ports with LED status indicators
8. Power cable socket

## Status Information

You can obtain information about the status of your storage system by reviewing the indicators listed in the following table.

**Table 10. Indicator descriptions ReadyNAS 422**

Indicator	Description
Front panel status display screen	Displays messages about the status of your storage system. Note that the status display screen goes to sleep to prevent burn-in. To wake the status display screen, press any button on the front panel. If the storage system reports an abnormal operation or error, the status display screen stays on.
Drive bay disk LEDs	<p>A disk LED next to each drive bay indicates the status of the disk inside. The disk LEDs indicate these states:</p> <ul style="list-style-type: none"> <li>• <b>Solid blue.</b> Power is on and the disk is operating normally.</li> <li>• <b>Blinking blue.</b> The disk is active.</li> <li>• <b>Solid red.</b> The disk was removed, failed, or is resynchronizing. See the display screen for details.</li> <li>• <b>Off.</b> No disk is present.</li> </ul>
Rear panel 1G Ethernet LAN port LEDs	<p>Two LED status indicators are built into each 1G Ethernet port. One LED is a bicolor LED that can light solid amber or solid green and indicates the port speed. The other LED is green and indicates the link (solid green) and activity (blinking green). These LEDs indicate port speed and activity as follows:</p> <ul style="list-style-type: none"> <li>• <b>Bicolor LED green, green LED solid.</b> 1 Gbps connection speed, no activity.</li> <li>• <b>Bicolor LED green, green LED blinking.</b> 1 Gbps connection speed, activity.</li> <li>• <b>Bicolor LED amber, green LED solid.</b> 100 Mbps connection speed, no activity.</li> <li>• <b>Bicolor LED amber, green LED blinking.</b> 100 Mbps connection speed, activity.</li> <li>• <b>Bicolor LED off, green LED off.</b> Either no connection or 10 Mbps connection without activity.</li> <li>• <b>Bicolor LED off, green LED blinking.</b> 10 Mbps connection, activity.</li> </ul>

## Power On and Shut Down

This section describes how to power on and shut down your system. If you must shut down the system, use one of the preferred shutdown methods whenever possible.

### Power On

When you connect the system to a power supply or the system recovers from a power outage, the system returns to its last state:

- If the system was powered on, the system automatically powers on again when the power supply is connected or power is restored.
- If the system was powered off, the system remains off when the power supply is connected or power is restored.  
In this situation, press the **Power** button on the front panel of the system to power on the system.

### Preferred Shutdown

You can gracefully shut down your system by using the **Power** button or the ReadyNAS local admin page.

For information about how to gracefully shut down your system using the ReadyNAS local admin page, see the *ReadyNAS OS 6 Software Manual*, which is available at [netgear.com/support/product/ReadyNAS\\_OS\\_6](http://netgear.com/support/product/ReadyNAS_OS_6).

#### ▶ To gracefully shut down your system using the Power button:

1. If the status display screen is not lit, do the following:
  - a. Press the **Power** button on the front panel of the system.  
The status display screen wakes.
  - b. Press the **Power** button a second time.  
Instructions for graceful shutdown display on the status display screen.
  - c. Press the **Power** button a third time.  
The system shuts down gracefully.
2. If the status display screen is lit, do the following:
  - a. Press the **Power** button on the front panel of the system.  
Instructions for graceful shutdown display on the status display screen.
  - b. Press the **Power** button again.  
The system shuts down gracefully.

### Forced Shutdown

Perform a forced shutdown only if the storage system is not responding.

#### ▶ To perform a forced shutdown:

Press and hold the **Power** button on the front panel of the system for five seconds.  
The LEDs blink quickly and simultaneously to warn that power will be cut off forcibly.

The system shuts down.



## Boot Menu

Use the boot menu to restart or troubleshoot your ReadyNAS storage system. Your storage system has the following boot modes:

- **Normal.** Initiates a normal boot process, just like booting using the **Power** button.
- **Factory default.** Initiates a short disk test that takes approximately 2 minutes. After the disk test, a 10-minute time-out period begins, during which all LEDs blink simultaneously.



**WARNING:**

**The factory default reboot process resets the storage system to factory settings, erases all data, resets all defaults, and reformats the disk to X-RAID.**

- If you want to cancel the factory default process, power off the storage system before the 10-minute time-out ends. The system powers down safely without causing any data loss.
- If you want to reset the system to factory default settings, do not power off your system. After the 10-minute time-out period, the factory default process begins.

**Tip** To start the factory default process immediately, press the **OK** button during the 10-minute time-out period.

- **OS reinstall.** Reinstalls the firmware from the internal flash to the disks. Use the OS reinstall boot mode when the system crashes and corrupts some configuration files. OS reinstall boot mode also resets some settings on your storage system, such as IP settings and the administrator password, to defaults.
- **Tech support.** Boots into a low-level diagnostic mode. Use the tech support boot mode only when instructed to do so by a NETGEAR technical support representative.
- **Volume read only.** Mounts a volume as read-only. Use this option when you are attempting to rescue data off a disk during a disaster recovery.
- **Memory test.** Performs a memory test. The pass or fail result is reported on the status display screen.
- **Test disk.** Performs an offline full disk test. This process can take four hours or more, depending on the size of your disks. Any problems are reported in the system logs. For more information about viewing the system logs, see the *ReadyNAS OS 6 Software Manual*, which is available at [netgear.com/support/product/ReadyNAS\\_OS\\_6](http://netgear.com/support/product/ReadyNAS_OS_6).

### ▶ To access the boot menu:

1. Power off your storage system.
2. Using a straightened paper clip, press and hold the **Reset** button.
3. Press the **Power** button on the front panel of the system.  
The system powers on.
4. Continue to press the **Reset** button until the status display screen shows a boot menu message.
5. Use the **Up** and **Down** buttons on the front panel to scroll through boot mode options.

## ReadyNAS OS 6 Desktop Storage Systems

The status display screen shows the current boot mode option.

6. When the status display screen shows the boot mode that you need, press the **OK** button to confirm your boot menu selection.

The system boots in the selected boot mode.

This chapter provides an overview of the physical features of the ReadyNAS 424 and includes the following sections:

- *Front and Side Panels* on page 92
- *Drive Bays* on page 93
- *Rear Panel* on page 94
- *Status Information* on page 95
- *Power On and Shut Down* on page 95
- *Boot Menu* on page 97

## Front and Side Panels

The following figure shows the front and side panels of the ReadyNAS 424.

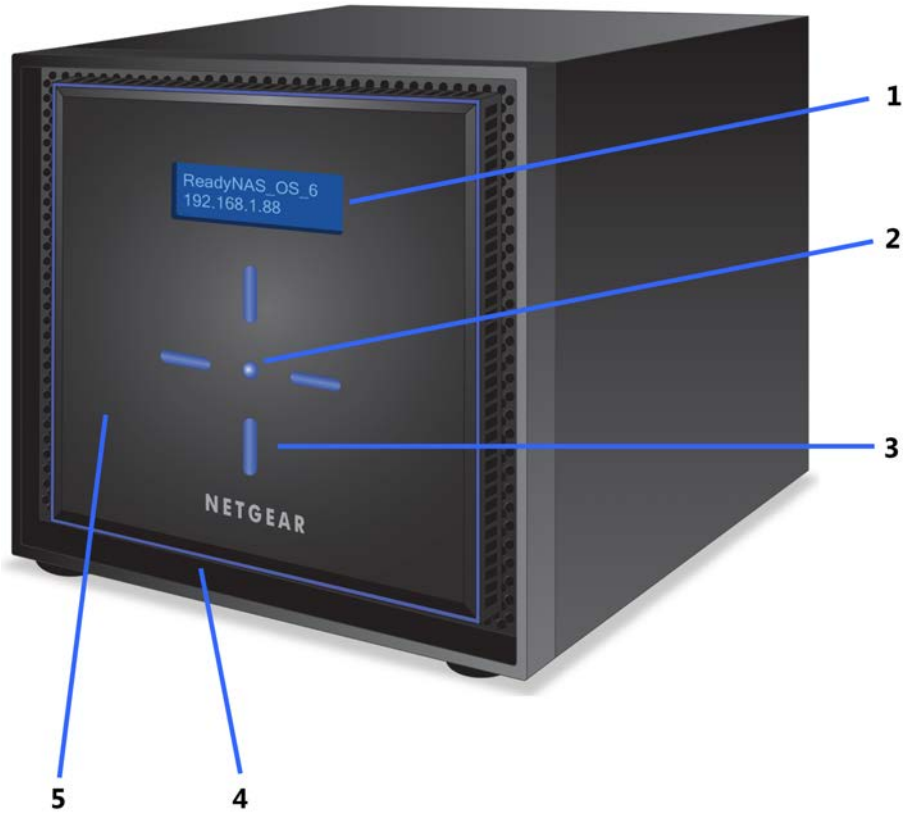

Figure 33. ReadyNAS 424 front and side panels

1. Status and menu display screen
2. OK button
3. Four buttons (Up, Down, Left, Right) and backlights
4. USB 3.0 port
5. Drive bay door

## Drive Bays

The following figure shows the drive bays of ReadyNAS 424.

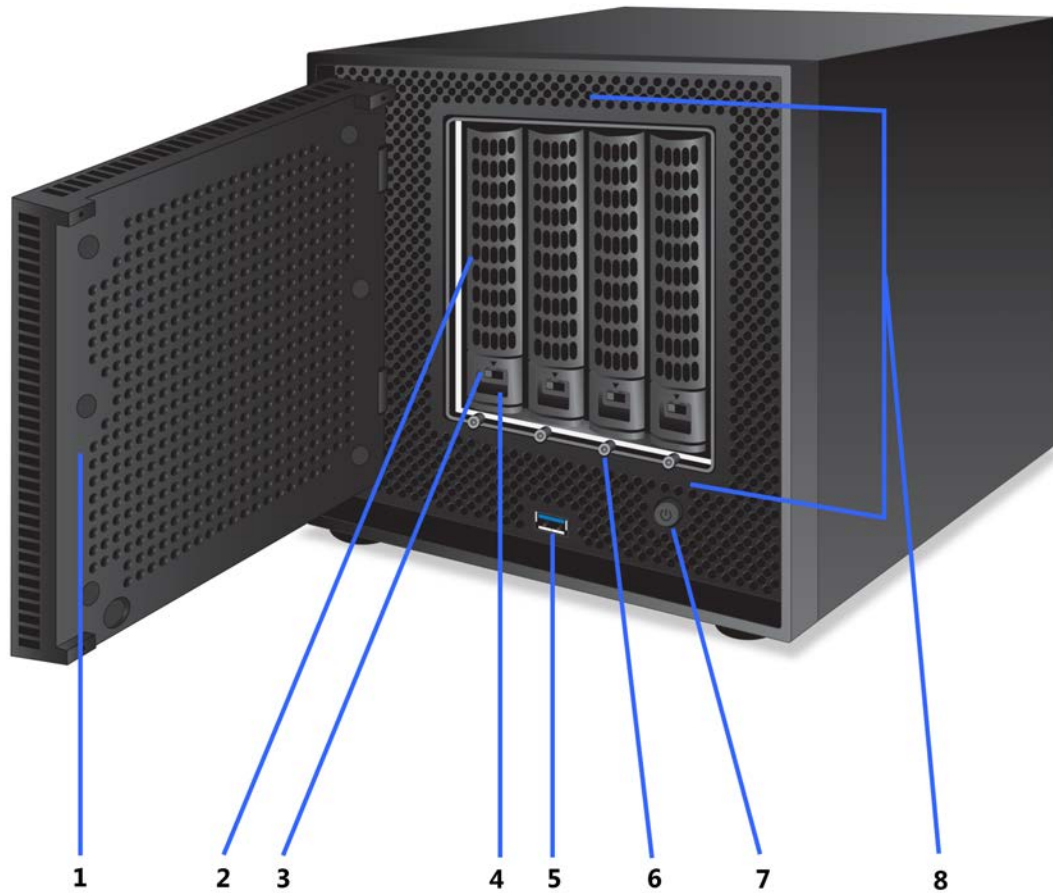

Figure 34. ReadyNAS 424 drive bays

1. Drive bay door
2. Disk tray handle
3. Disk tray release latch
4. Recessed disk tray handle lock
5. USB 3.0 port
6. Disk LED
7. Power button
8. Drive bays

## Rear Panel

The following figure shows the rear panel of the ReadyNAS 424.

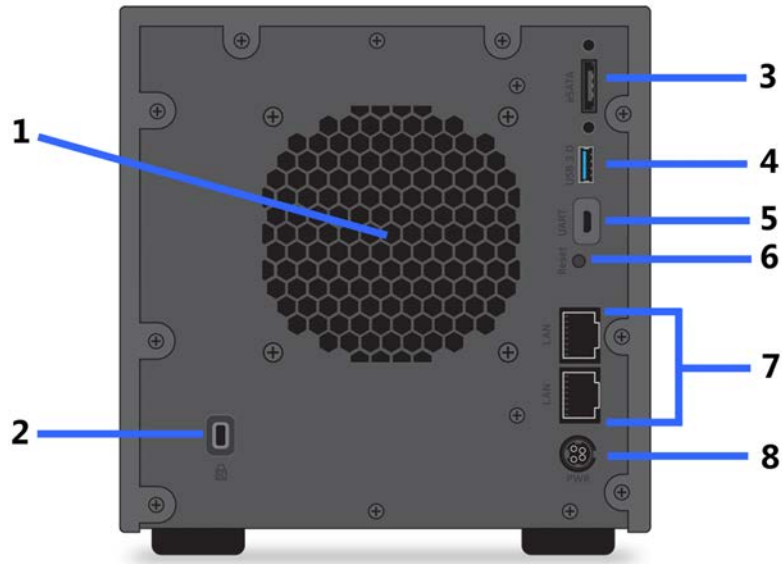

Figure 35. Rear panel ReadyNAS 424

1. Exhaust fan
2. Kensington lock
3. eSATA port
4. USB 3.0 port
5. Micro USB console connector (marked as UART)
6. Reset button
7. 1 GbE LAN ports with LED status indicators
8. Power cable socket

## Status Information

You can obtain information about the status of your storage system by reviewing the indicators listed in the following table.

**Table 11. Indicator descriptions ReadyNAS 424**

Indicator	Description
Front panel status display screen	Displays messages about the status of your storage system. Note that the status display screen goes to sleep to prevent burn-in. To wake the status display screen, press any button on the front panel. If the storage system reports an abnormal operation or error, the status display screen stays on.
Drive bay disk LEDs	<p>A disk LED next to each drive bay indicates the status of the disk inside. The disk LEDs indicate these states:</p> <ul style="list-style-type: none"> <li>• <b>Solid blue.</b> Power is on and the disk is operating normally.</li> <li>• <b>Blinking blue.</b> The disk is active.</li> <li>• <b>Solid red.</b> The disk was removed, failed, or is resynchronizing. See the display screen for details.</li> <li>• <b>Off.</b> No disk is present.</li> </ul>
Rear panel 1G Ethernet LAN port LEDs	<p>Two LED status indicators are built into each 1G Ethernet port. One LED is a bicolor LED that can light solid amber or solid green and indicates the port speed. The other LED is green and indicates the link (solid green) and activity (blinking green). These LEDs indicate port speed and activity as follows:</p> <ul style="list-style-type: none"> <li>• <b>Bicolor LED green, green LED solid.</b> 1 Gbps connection speed, no activity.</li> <li>• <b>Bicolor LED green, green LED blinking.</b> 1 Gbps connection speed, activity.</li> <li>• <b>Bicolor LED amber, green LED solid.</b> 100 Mbps connection speed, no activity.</li> <li>• <b>Bicolor LED amber, green LED blinking.</b> 100 Mbps connection speed, activity.</li> <li>• <b>Bicolor LED off, green LED off.</b> Either no connection or 10 Mbps connection without activity.</li> <li>• <b>Bicolor LED off, green LED blinking.</b> 10 Mbps connection, activity.</li> </ul>

## Power On and Shut Down

This section describes how to power on and shut down your system. If you must shut down the system, use one of the preferred shutdown methods whenever possible.

### Power On

When you connect the system to a power supply or the system recovers from a power outage, the system returns to its last state:

- If the system was powered on, the system automatically powers on again when the power supply is connected or power is restored.
- If the system was powered off, the system remains off when the power supply is connected or power is restored.  
In this situation, press the **Power** button on the front panel of the system to power on the system.

### Preferred Shutdown

You can gracefully shut down your system by using the **Power** button or the ReadyNAS local admin page.

For information about how to gracefully shut down your system using the ReadyNAS local admin page, see the *ReadyNAS OS 6 Software Manual*, which is available at [netgear.com/support/product/ReadyNAS\\_OS\\_6](http://netgear.com/support/product/ReadyNAS_OS_6).

#### ▶ To gracefully shut down your system using the Power button:

1. If the status display screen is not lit, do the following:
  - a. Press the **Power** button on the front panel of the system.  
The status display screen wakes.
  - b. Press the **Power** button a second time.  
Instructions for graceful shutdown display on the status display screen.
  - c. Press the **Power** button a third time.  
The system shuts down gracefully.
2. If the status display screen is lit, do the following:
  - a. Press the **Power** button on the front panel of the system.  
Instructions for graceful shutdown display on the status display screen.
  - b. Press the **Power** button again.  
The system shuts down gracefully.

### Forced Shutdown

Perform a forced shutdown only if the storage system is not responding.

#### ▶ To perform a forced shutdown:

Press and hold the **Power** button on the front panel of the system for five seconds.  
The LEDs blink quickly and simultaneously to warn that power will be cut off forcibly.

The system shuts down.



## Boot Menu

Use the boot menu to restart or troubleshoot your ReadyNAS storage system. Your storage system has the following boot modes:

- **Normal.** Initiates a normal boot process, just like booting using the **Power** button.
- **Factory default.** Initiates a short disk test that takes approximately 2 minutes. After the disk test, a 10-minute time-out period begins, during which all LEDs blink simultaneously.



**WARNING:**

**The factory default reboot process resets the storage system to factory settings, erases all data, resets all defaults, and reformats the disk to X-RAID.**

- If you want to cancel the factory default process, power off the storage system before the 10-minute time-out ends. The system powers down safely without causing any data loss.
- If you want to reset the system to factory default settings, do not power off your system. After the 10-minute time-out period, the factory default process begins.

**Tip** To start the factory default process immediately, press the **OK** button during the 10-minute time-out period.

- **OS reinstall.** Reinstalls the firmware from the internal flash to the disks. Use the OS reinstall boot mode when the system crashes and corrupts some configuration files. OS reinstall boot mode also resets some settings on your storage system, such as IP settings and the administrator password, to defaults.
- **Tech support.** Boots into a low-level diagnostic mode. Use the tech support boot mode only when instructed to do so by a NETGEAR technical support representative.
- **Volume read only.** Mounts a volume as read-only. Use this option when you are attempting to rescue data off a disk during a disaster recovery.
- **Memory test.** Performs a memory test. The pass or fail result is reported on the status display screen.
- **Test disk.** Performs an offline full disk test. This process can take four hours or more, depending on the size of your disks. Any problems are reported in the system logs. For more information about viewing the system logs, see the *ReadyNAS OS 6 Software Manual*, which is available at [netgear.com/support/product/ReadyNAS\\_OS\\_6](http://netgear.com/support/product/ReadyNAS_OS_6).

### ▶ To access the boot menu:

1. Power off your storage system.
2. Using a straightened paper clip, press and hold the **Reset** button.
3. Press the **Power** button on the front panel of the system.  
The system powers on.
4. Continue to press the **Reset** button until the status display screen shows a boot menu message.
5. Use the **Up** and **Down** buttons on the front panel to scroll through boot mode options.

## ReadyNAS OS 6 Desktop Storage Systems

The status display screen shows the current boot mode option.

6. When the status display screen shows the boot mode that you need, press the **OK** button to confirm your boot menu selection.

The system boots in the selected boot mode.

This chapter provides an overview of the physical features of the ReadyNAS 426 and includes the following sections:

- *Front and Side Panels* on page 100
- *Drive Bays* on page 101
- *Rear Panel* on page 102
- *Status Information* on page 103
- *Power On and Shut Down* on page 103
- *Boot Menu* on page 105

## Front and Side Panels

The following figure shows the front and side panels of the ReadyNAS 426.

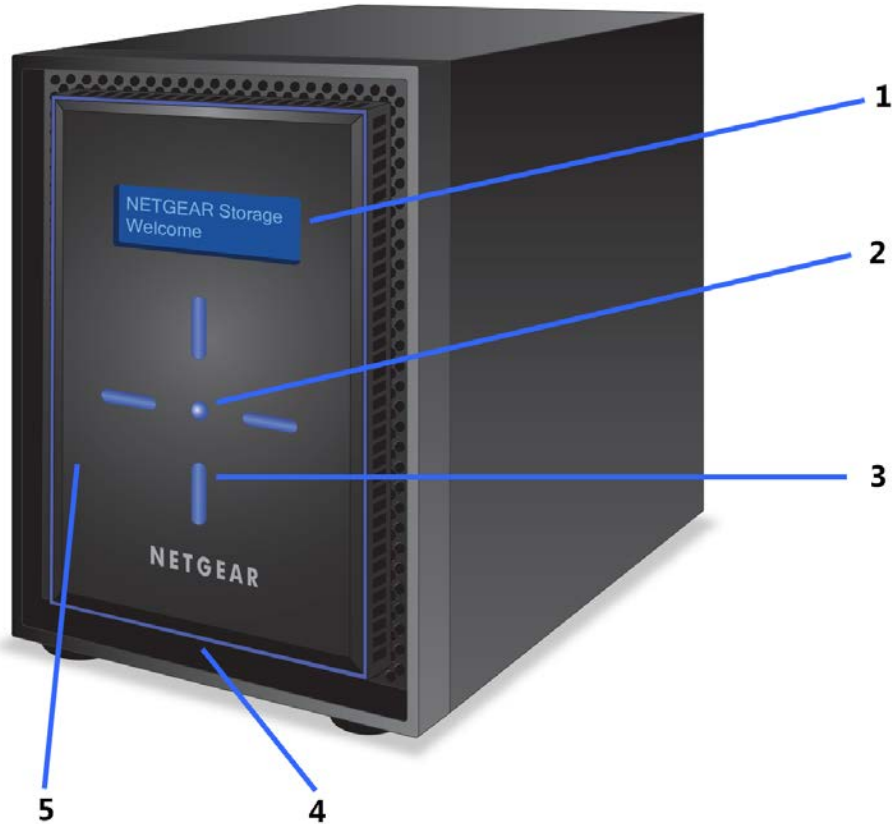

Figure 36. ReadyNAS 426 front and side panels

1. Status and menu display screen
2. OK button
3. Four buttons (Up, Down, Left, Right) and backlights
4. USB 3.0 port
5. Drive bay door

## Drive Bays

The following figure shows the drive bays of ReadyNAS 426.

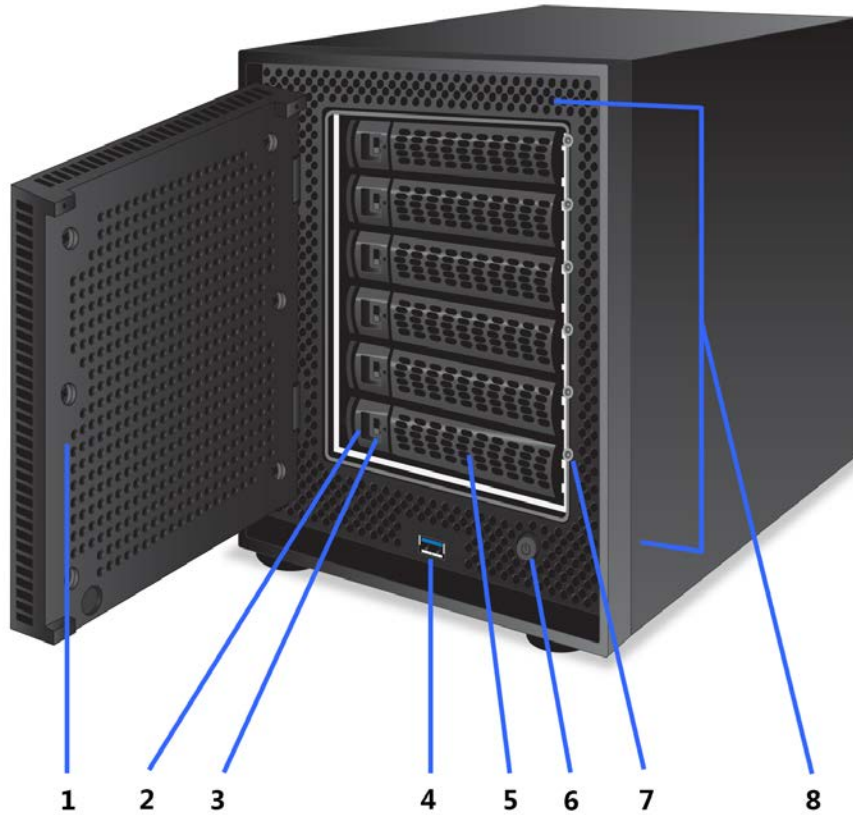

Figure 37. ReadyNAS 426 drive bays

1. Drive bay door
2. Disk tray release latch
3. Recessed disk tray handle lock
4. USB 3.0 port
5. Disk tray handle
6. Power button
7. Disk LED
8. Drive bays

## Rear Panel

The following figure shows the rear panel of the ReadyNAS 426.

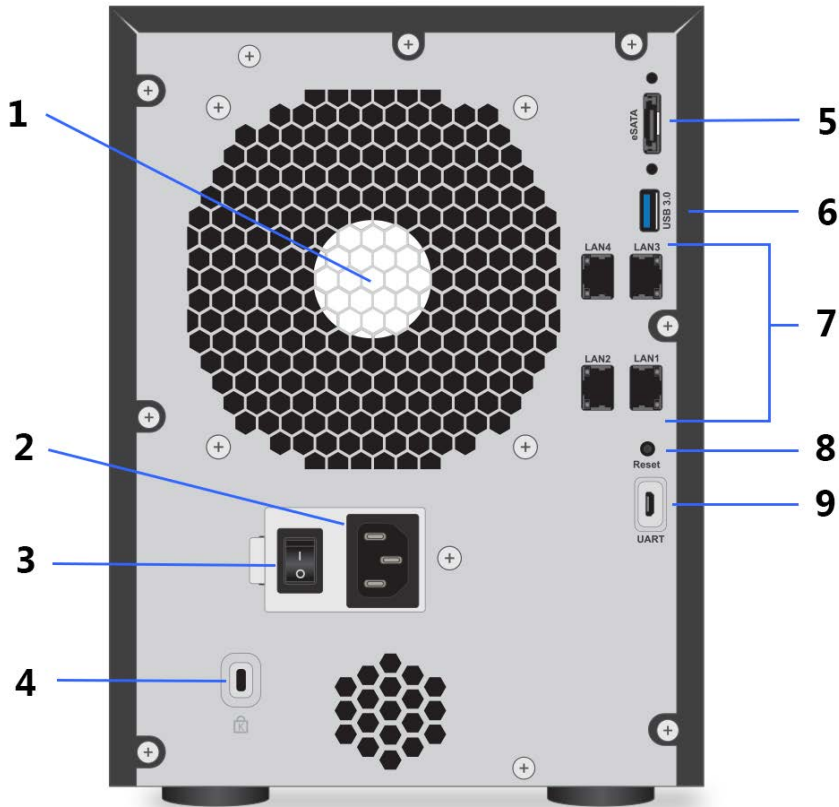

Figure 38. ReadyNAS 426 rear panel

1. Exhaust fan
2. Power cable socket
3. Power switch
4. Kensington lock
5. eSATA port
6. USB 3.0 port
7. Four 1 GbE LAN ports with LED status indicators
8. Reset button
9. Micro USB console connector (marked as UART)

## Status Information

You can obtain information about the status of your storage system by reviewing the indicators listed in the following table.

**Table 12. Indicator descriptions ReadyNAS 426**

Indicator	Description
Front panel status display screen	Displays messages about the status of your storage system. Note that the status display screen goes to sleep to prevent burn-in. To wake the status display screen, press any button on the front panel. If the storage system reports an abnormal operation or error, the status display screen stays on.
Drive bay disk LEDs	<p>A disk LED next to each drive bay indicates the status of the disk inside. The disk LEDs indicate these states:</p> <ul style="list-style-type: none"> <li>• <b>Solid blue.</b> Power is on and the disk is operating normally.</li> <li>• <b>Blinking blue.</b> The disk is active.</li> <li>• <b>Solid red.</b> The disk was removed, failed, or is resynchronizing. See the display screen for details.</li> <li>• <b>Off.</b> No disk is present.</li> </ul>
Rear panel 1G Ethernet LAN port LEDs	<p>Two LED status indicators are built into each 1G Ethernet port. One LED is a bicolor LED that can light solid amber or solid green and indicates the port speed. The other LED is green and indicates the link (solid green) and activity (blinking green). These LEDs indicate port speed and activity as follows:</p> <ul style="list-style-type: none"> <li>• <b>Bicolor LED green, green LED solid.</b> 1 Gbps connection speed, no activity.</li> <li>• <b>Bicolor LED green, green LED blinking.</b> 1 Gbps connection speed, activity.</li> <li>• <b>Bicolor LED amber, green LED solid.</b> 100 Mbps connection speed, no activity.</li> <li>• <b>Bicolor LED off, green LED off.</b> Either no connection or 10 Mbps connection without activity.</li> <li>• <b>Bicolor LED off, green LED blinking.</b> 10 Mbps connection, activity.</li> </ul>

## Power On and Shut Down

This section describes how to power on and shut down your system. If you must shut down the system, use one of the preferred shutdown methods whenever possible.

### Power On

When you connect the system to a power supply and the **Power** switch is in the On position or the system recovers from a power outage and the **Power** switch is in the On position, the following occurs:

- The system automatically powers on if you enabled the Wake on LAN (WoL) feature or scheduled the system to automatically power on or off.
- The system returns to its last state if the Wake on LAN (WoL) feature is disabled and you did not schedule the system to automatically power on or off:
  - If the system was powered on, the system automatically powers on again when the power supply is connected or power is restored.
  - If the system was powered off, the system remains off when the power supply is connected or power is restored.In this situation, press the **Power** button on the front panel of the system to power on the system.

### Preferred Shutdown

You can gracefully shut down your system by using the **Power** button or the ReadyNAS local admin page.

For information about how to gracefully shut down your system using the ReadyNAS local admin page, see the *ReadyNAS OS 6 Software Manual*, which is available at [netgear.com/support/product/ReadyNAS\\_OS\\_6](http://netgear.com/support/product/ReadyNAS_OS_6).

#### ► To gracefully shut down your system using the Power button:

1. If the status display screen is not lit, do the following:
  - a. Press the **Power** button on the front panel of the system.  
The status display screen wakes.
  - b. Press the **Power** button a second time.  
Instructions for graceful shutdown display on the status display screen.
  - c. Press the **Power** button a third time.  
The system shuts down gracefully.
2. If the status display screen is lit, do the following:
  - a. Press the **Power** button on the front panel of the system.  
Instructions for graceful shutdown display on the status display screen.
  - b. Press the **Power** button again.  
The system shuts down gracefully.



### Forced Shutdown

Perform a forced shutdown only if the storage system is not responding.

#### ▶ To perform a forced shutdown:

Press and hold the **Power** button on the front panel of the system for five seconds.  
The LEDs blink quickly and simultaneously to warn that power will be cut off forcibly.

The system shuts down.

### Boot Menu

Use the boot menu to restart or troubleshoot your ReadyNAS storage system. Your storage system has the following boot modes:

- **Normal.** Initiates a normal boot process, just like booting using the **Power** button.
- **Factory default.** Initiates a short disk test that takes approximately 2 minutes. After the disk test, a 10-minute time-out period begins, during which all LEDs blink simultaneously.



#### **WARNING:**

**The factory default reboot process resets the storage system to factory settings, erases all data, resets all defaults, and reformats the disk to X-RAID.**

- If you want to cancel the factory default process, power off the storage system before the 10-minute time-out ends. The system powers down safely without causing any data loss.
- If you want to reset the system to factory default settings, do not power off your system. After the 10-minute time-out period, the factory default process begins.

**Tip** To start the factory default process immediately, press the **OK** button during the 10-minute time-out period.

- **OS reinstall.** Reinstalls the firmware from the internal flash to the disks. Use the OS reinstall boot mode when the system crashes and corrupts some configuration files. OS reinstall boot mode also resets some settings on your storage system, such as IP settings and the administrator password, to defaults.
- **Tech support.** Boots into a low-level diagnostic mode. Use the tech support boot mode only when instructed to do so by a NETGEAR technical support representative.
- **Volume read only.** Mounts a volume as read-only. Use this option when you are attempting to rescue data off a disk during a disaster recovery.
- **Memory test.** Performs a memory test. The pass or fail result is reported on the status display screen.
- **Test disk.** Performs an offline full disk test. This process can take four hours or more, depending on the size of your disks. Any problems are reported in the system logs. For more information about viewing the system logs, see the *ReadyNAS OS 6 Software Manual*, which is available at [netgear.com/support/product/ReadyNAS\\_OS\\_6](http://netgear.com/support/product/ReadyNAS_OS_6).

### ▶ To access the boot menu:

1. Power off your storage system.
2. Using a straightened paper clip, press and hold the **Reset** button.
3. Press the **Power** button on the front panel of the system.  
The system powers on.
4. Continue to press the **Reset** button until the status display screen shows a boot menu message.
5. Use the **Up** and **Down** buttons on the front panel to scroll through boot mode options.  
The status display screen shows the current boot mode option.
6. When the status display screen shows the boot mode that you need, press the **OK** button to confirm your boot menu selection.  
The system boots in the selected boot mode.

This chapter provides an overview of the physical features of the ReadyNAS 428 and includes the following sections:

- *Front and Side Panels* on page 108
- *Drive Bays* on page 109
- *Rear Panel* on page 110
- *Status Information* on page 111
- *Power On and Shut Down* on page 111
- *Boot Menu* on page 113

## Front and Side Panels

The following figure shows the front and side panels of the ReadyNAS 428.



Figure 39. ReadyNAS 428 front and side panels

1. Status and menu display screen
2. OK button
3. Four buttons (Up, Down, Left, Right) and backlights
4. USB 3.0 port
5. Drive bay door

## Drive Bays

The following figure shows the drive bays of ReadyNAS 428.

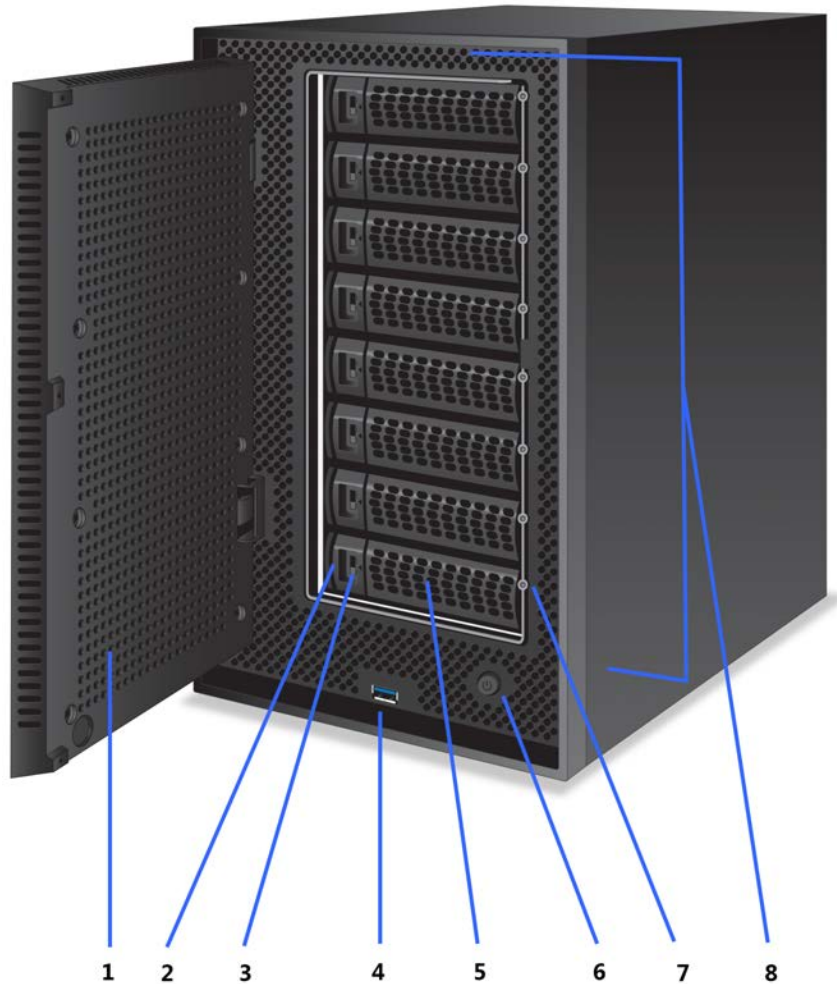

Figure 40. ReadyNAS 428 drive bays

1. Drive bay door
2. Disk tray release latch
3. Recessed disk tray handle lock
4. USB 3.0 port
5. Disk tray handle
6. Power button
7. Disk LED
8. Drive bays

## Rear Panel

The following figure shows the rear panel of the ReadyNAS 428.

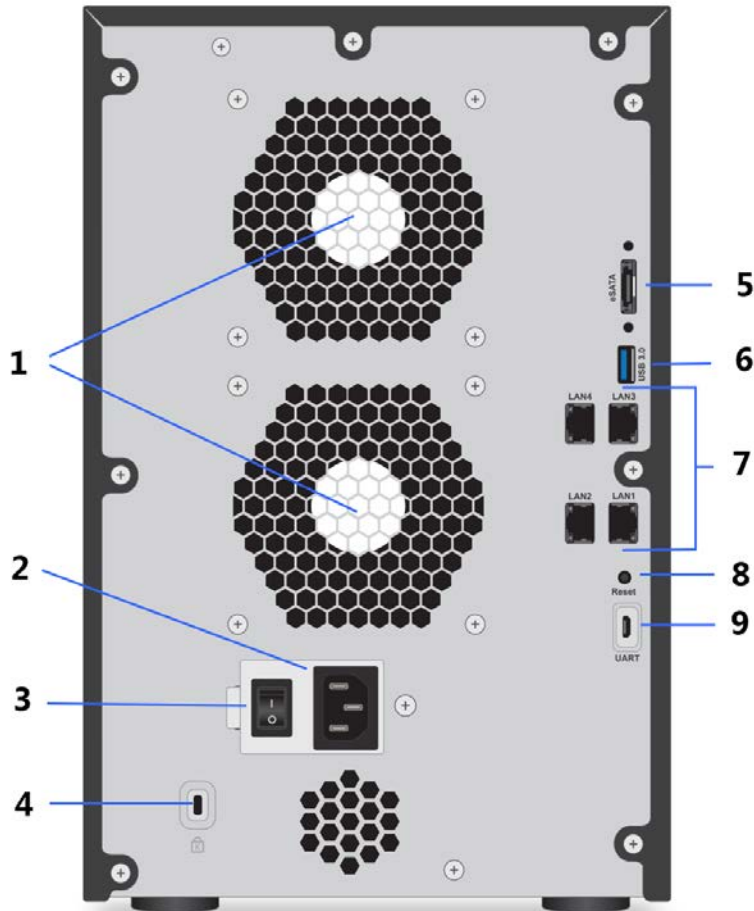

Figure 41. ReadyNAS 428 rear panel

1. Two exhaust fans
2. Power cable socket
3. Power switch
4. Kensington lock
5. eSATA port
6. USB 3.0 port
7. Four 1 GbE LAN ports with LED status indicators
8. Reset button
9. Micro USB console connector (marked as UART)

## Status Information

You can obtain information about the status of your storage system by reviewing the indicators listed in the following table.

**Table 13. Indicator descriptions ReadyNAS 428**

Indicator	Description
Front panel status display screen	Displays messages about the status of your storage system. Note that the status display screen goes to sleep to prevent burn-in. To wake the status display screen, press any button on the front panel. If the storage system reports an abnormal operation or error, the status display screen stays on.
Drive bay disk LEDs	<p>A disk LED next to each drive bay indicates the status of the disk inside. The disk LEDs indicate these states:</p> <ul style="list-style-type: none"> <li>• <b>Solid blue.</b> Power is on and the disk is operating normally.</li> <li>• <b>Blinking blue.</b> The disk is active.</li> <li>• <b>Solid red.</b> The disk was removed, failed, or is resynchronizing. See the display screen for details.</li> <li>• <b>Off.</b> No disk is present.</li> </ul>
Rear panel 1G Ethernet LAN port LEDs	<p>Two LED status indicators are built into each 1G Ethernet port. One LED is a bicolor LED that can light solid amber or solid green and indicates the port speed. The other LED is green and indicates the link (solid green) and activity (blinking green). These LEDs indicate port speed and activity as follows:</p> <ul style="list-style-type: none"> <li>• <b>Bicolor LED green, green LED solid.</b> 1 Gbps connection speed, no activity.</li> <li>• <b>Bicolor LED green, green LED blinking.</b> 1 Gbps connection speed, activity.</li> <li>• <b>Bicolor LED amber, green LED solid.</b> 100 Mbps connection speed, no activity.</li> <li>• <b>Bicolor LED off, green LED off.</b> Either no connection or 10 Mbps connection without activity.</li> <li>• <b>Bicolor LED off, green LED blinking.</b> 10 Mbps connection, activity.</li> </ul>

## Power On and Shut Down

This section describes how to power on and shut down your system. If you must shut down the system, use one of the preferred shutdown methods whenever possible.

### Power On

When you connect the system to a power supply and the **Power** switch is in the On position or the system recovers from a power outage and the **Power** switch is in the On position, the system returns to its last state:

- If the system was powered on, the system automatically powers on again when the power supply is connected or power is restored.
- If the system was powered off, the system remains off when the power supply is connected or power is restored.  
In this situation, press the **Power** button on the front panel of the system to power on the system.

### Preferred Shutdown

You can gracefully shut down your system by using the **Power** button or the ReadyNAS local admin page.

For information about how to gracefully shut down your system using the ReadyNAS local admin page, see the *ReadyNAS OS 6 Software Manual*, which is available at [netgear.com/support/product/ReadyNAS\\_OS\\_6](http://netgear.com/support/product/ReadyNAS_OS_6).

#### ► To gracefully shut down your system using the Power button:

1. If the status display screen is not lit, do the following:
  - a. Press the **Power** button on the front panel of the system.  
The status display screen wakes.
  - b. Press the **Power** button a second time.  
Instructions for graceful shutdown display on the status display screen.
  - c. Press the **Power** button a third time.  
The system shuts down gracefully.
2. If the status display screen is lit, do the following:
  - a. Press the **Power** button on the front panel of the system.  
Instructions for graceful shutdown display on the status display screen.
  - b. Press the **Power** button again.  
The system shuts down gracefully.

### Forced Shutdown

Perform a forced shutdown only if the storage system is not responding.

#### ► To perform a forced shutdown:

Press and hold the **Power** button on the front panel of the system for five seconds.  
The LEDs blink quickly and simultaneously to warn that power will be cut off forcibly.

The system shuts down.



# Boot Menu

Use the boot menu to restart or troubleshoot your ReadyNAS storage system. Your storage system has the following boot modes:

- **Normal.** Initiates a normal boot process, just like booting using the **Power** button.
- **Factory default.** Initiates a short disk test that takes approximately 2 minutes. After the disk test, a 10-minute time-out period begins, during which all LEDs blink simultaneously.



**WARNING:**

**The factory default reboot process resets the storage system to factory settings, erases all data, resets all defaults, and reformats the disk to X-RAID.**

- If you want to cancel the factory default process, power off the storage system before the 10-minute time-out ends. The system powers down safely without causing any data loss.
- If you want to reset the system to factory default settings, do not power off your system. After the 10-minute time-out period, the factory default process begins.

**Tip** To start the factory default process immediately, press the **OK** button during the 10-minute time-out period.

- **OS reinstall.** Reinstalls the firmware from the internal flash to the disks. Use the OS reinstall boot mode when the system crashes and corrupts some configuration files. OS reinstall boot mode also resets some settings on your storage system, such as IP settings and the administrator password, to defaults.
- **Tech support.** Boots into a low-level diagnostic mode. Use the tech support boot mode only when instructed to do so by a NETGEAR technical support representative.
- **Volume read only.** Mounts a volume as read-only. Use this option when you are attempting to rescue data off a disk during a disaster recovery.
- **Memory test.** Performs a memory test. The pass or fail result is reported on the status display screen.
- **Test disk.** Performs an offline full disk test. This process can take four hours or more, depending on the size of your disks. Any problems are reported in the system logs. For more information about viewing the system logs, see the *ReadyNAS OS 6 Software Manual*, which is available at [netgear.com/support/product/ReadyNAS\\_OS\\_6](http://netgear.com/support/product/ReadyNAS_OS_6).

► **To access the boot menu:**

1. Power off your storage system.
2. Using a straightened paper clip, press and hold the **Reset** button.
3. Press the **Power** button on the front panel of the system.  
The system powers on.
4. Continue to press the **Reset** button until the status display screen shows a boot menu message.
5. Use the **Up** and **Down** buttons on the front panel to scroll through boot mode options.

## ReadyNAS OS 6 Desktop Storage Systems

The status display screen shows the current boot mode option.

6. When the status display screen shows the boot mode that you need, press the **OK** button to confirm your boot menu selection.

The system boots in the selected boot mode.

This chapter provides an overview of the physical features of the ReadyNAS 516 and includes the following sections:

- *Front and Side Panels* on page 116
- *Drive Bays* on page 116
- *Rear Panel* on page 117
- *Status Information* on page 118
- *Power On and Shut Down* on page 119
- *Boot Menu* on page 120

## Front and Side Panels

The following figure shows the front and side panels of the ReadyNAS 516.



Figure 42. ReadyNAS 516 front and side panels

1. Status and menu display screen
2. Infrared remote receiver
3. Drive bay door
4. Touch pad and backlight
5. OK button

## Drive Bays

The following figure shows the drive bays of the ReadyNAS 516.

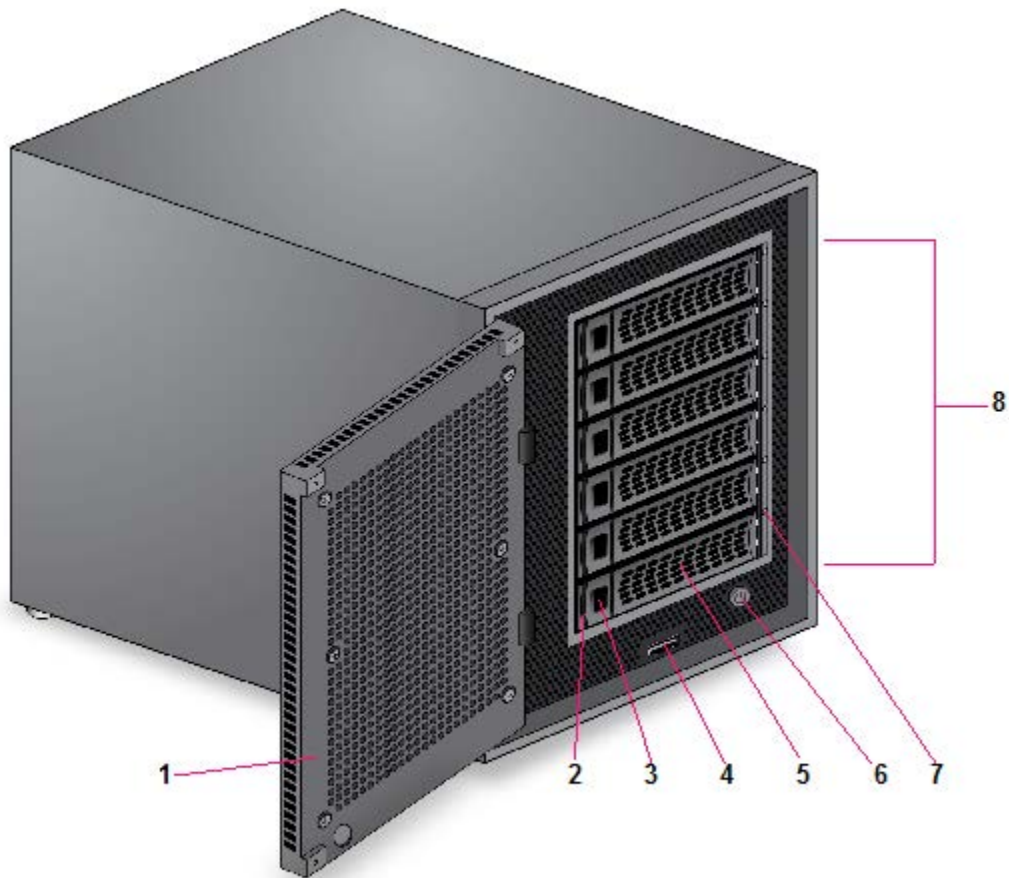

Figure 43. ReadyNAS 516 drive bays

1. Drive bay door
2. Disk tray release latch
3. Recessed disk tray handle lock
4. USB 2.0 port
5. Disk tray handle
6. Power button
7. Disk LED
8. Drive bays

## Rear Panel

The following figure shows the rear panel of the ReadyNAS 516.

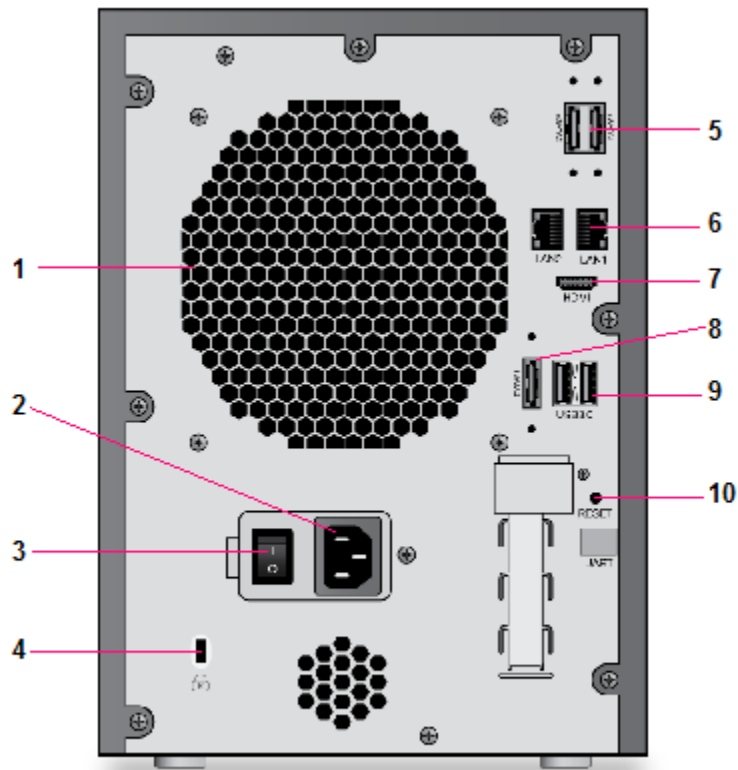

Figure 44. ReadyNAS 516 rear panel

1. Exhaust fan
2. Power cable socket
3. Power switch
4. Kensington lock
5. eSATA ports
6. LAN ports with LED status indicators
7. HDMI port (currently not supported)
8. eSATA port
9. USB 3.0 ports
10. Reset button

## Status Information

You can obtain information about the status of your storage system by reviewing the indicators listed in the following table.

**Table 14. ReadyNAS 516 indicator descriptions**

Indicator	Description
Disk LEDs	<p>A disk LED next to each drive bay indicates the status of the disk inside. The disk LEDs indicate these states:</p> <ul style="list-style-type: none"> <li>• <b>Solid blue.</b> Power is on and the disk is operating normally.</li> <li>• <b>Blinking blue.</b> The disk is active.</li> <li>• <b>Solid red.</b> The disk was removed, failed, or is resynchronizing. See the display screen for details.</li> <li>• <b>Off.</b> No disk is present.</li> </ul>
Rear panel Ethernet port LEDs	<p>Two LED status indicators are built into this port, one green and one amber. They indicate port speed and activity as follows:</p> <ul style="list-style-type: none"> <li>• <b>Green on, amber off.</b> 1000 Mbps connection speed, no activity.</li> <li>• <b>Green blinking, amber off.</b> 1000 Mbps connection speed, activity.</li> <li>• <b>Green off, amber on.</b> 10 Mbps or 100 Mbps connection speed, no activity.</li> <li>• <b>Green off, amber blinking.</b> 10 Mbps or 100 Mbps connection speed, activity.</li> <li>• <b>Green off, amber off.</b> No connection.</li> </ul>
Status display screen	<p>Displays messages about the status of your storage system. Note that the status display screen goes to sleep to prevent burn-in. To wake the status display screen, activate the proximity sensor, press the touch pad, press the <b>OK</b> button, or press the <b>Power</b> button once. If the storage system reports an abnormal operation or error, the status display screen stays on.</p>

## Power On and Shut Down

This section describes how to power on and shut down your system. If you must shut down the system, use one of the preferred shutdown methods whenever possible.

### Power On

When you connect the system to a power supply and the **Power** switch is in the On position or the system recovers from a power outage and the **Power** switch is in the On position, the following occurs:

- The system automatically powers on if you enabled the Wake on LAN (WoL) feature or scheduled the system to automatically power on or off.
- The system returns to its last state if the Wake on LAN (WoL) feature is disabled and you did not schedule the system to automatically power on or off:

- If the system was powered on, the system automatically powers on again when the power supply is connected or power is restored.
- If the system was powered off, the system remains off when the power supply is connected or power is restored.  
In this situation, press the **Power** button on the front panel of the system to power on the system.

## Preferred Shutdown

You can gracefully shut down your system by using the **Power** button or the ReadyNAS local admin page.

For information about how to gracefully shut down your system using the ReadyNAS local admin page, see the *ReadyNAS OS 6 Software Manual*, which is available at [netgear.com/support/product/ReadyNAS\\_OS\\_6](http://netgear.com/support/product/ReadyNAS_OS_6).

### ► To gracefully shut down your system using the Power button:

1. If the status display screen is not lit, do the following:
  - a. Press the **Power** button on the front panel of the system.  
The status display screen wakes.
  - b. Press the **Power** button a second time.  
Instructions for graceful shutdown display on the status display screen.
  - c. Press the **Power** button a third time.  
The system shuts down gracefully.
2. If the status display screen is lit, do the following:
  - a. Press the **Power** button on the front panel of the system.  
Instructions for graceful shutdown display on the status display screen.
  - b. Press the **Power** button again.  
The system shuts down gracefully.

## Forced Shutdown

Perform a forced shutdown only if the storage system is not responding.

### ► To perform a forced shutdown:

- Press and hold the **Power** button on the front panel of the system for five seconds.  
The LEDs blink quickly and simultaneously to warn that power will be cut off forcibly.

The system shuts down.

## Boot Menu

Use the boot menu to restart or troubleshoot your ReadyNAS storage system. Your storage system has the following boot modes:



## ReadyNAS OS 6 Desktop Storage Systems

- **Normal.** Initiates a normal boot process, just like booting using the **Power** button.
- **Factory default.** Initiates a short disk test that takes approximately 2 minutes. After the disk test, a 10-minute time-out period begins, during which all LEDs blink simultaneously.



### **WARNING:**

The factory default reboot process resets the storage system to factory settings, erases all data, resets all defaults, and reformats the disk to X-RAID.

- If you want to cancel the factory default process, power off the storage system before the 10-minute time-out ends. The system powers down safely without causing any data loss.
- If you want to reset the system to factory default settings, do not power off your system. After the 10-minute time-out period, the factory default process begins.

**Tip** To start the factory default process immediately, press the **OK** button during the 10-minute time-out period.

- **OS reinstall.** Reinstalls the firmware from the internal flash to the disks. Use the OS reinstall boot mode when the system crashes and corrupts some configuration files. OS reinstall boot mode also resets some settings on your storage system, such as Internet protocol settings and the administrator password, to defaults.
- **Tech support.** Boots into a low-level diagnostic mode. Use the tech support boot mode only when a NETGEAR technical support representative instructs you to do so.
- **Volume read only.** Mounts a volume as read-only. Use this option when you are attempting to rescue data off a disk during a disaster recovery.
- **Memory test.** Performs a memory test. The pass or fail result is reported on the status display screen.
- **Test disk.** Performs an offline full disk test. This process can take four hours or more, depending on the size of your disks. Any problems are reported in the system logs. For more information about viewing the system logs, see the *ReadyNAS OS 6 Software Manual*, which is available at [netgear.com/support/product/ReadyNAS\\_OS\\_6](http://netgear.com/support/product/ReadyNAS_OS_6).

### ► To access the boot menu:

1. Power off your storage system.
2. Using a straightened paper clip, press and hold the **Reset** button.
3. Press the **Power** button on the front panel of the system.  
The system powers on.
4. Continue to press the **Reset** button until the status display screen shows a boot menu message.
5. Use the arrows on the touch pad to scroll through boot mode options.  
The status display screen shows the current boot mode option.
6. When the status display screen shows the boot mode that you need, press the **OK** button to confirm your boot menu selection.  
The system boots in the selected boot mode.

This chapter provides an overview of the physical features of the ReadyNAS 524X and includes the following sections:

- *Front and Side Panels* on page 123
- *Drive Bays* on page 124
- *Rear Panel* on page 125
- *Status Information* on page 126
- *Power On and Shut Down* on page 127
- *Boot Menu* on page 128

## Front and Side Panels

The following figure shows the front and side panels of the ReadyNAS 524X.

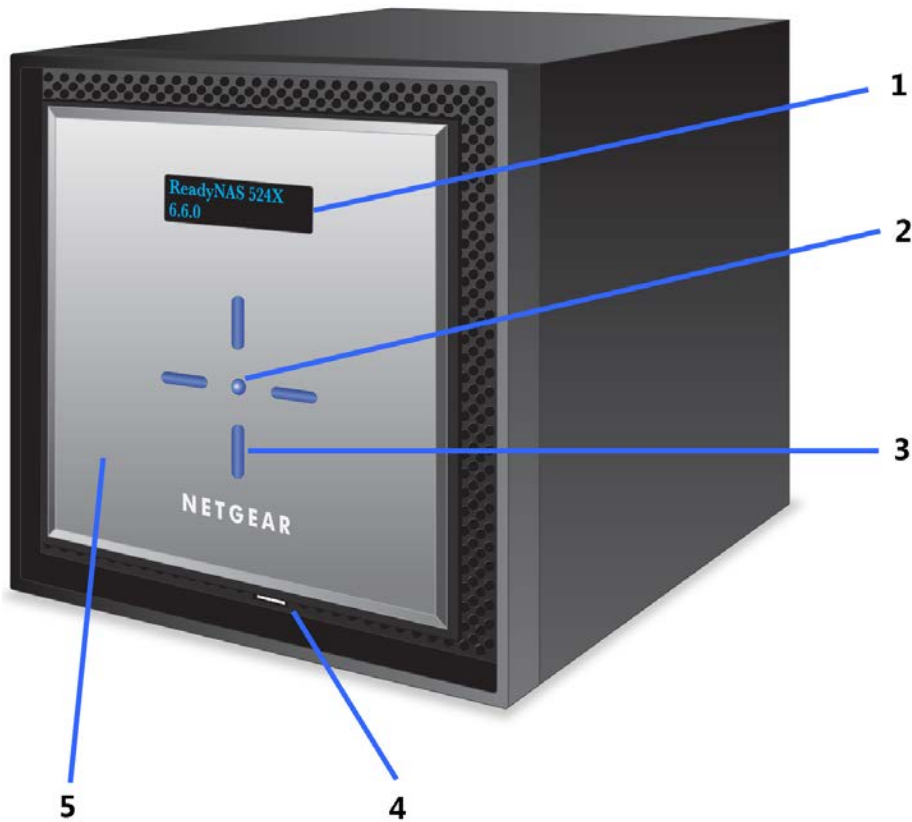

Figure 45. ReadyNAS 524X front and side panels

1. Status and menu display screen
2. OK button
3. Four buttons (Up, Down, Left, Right) and backlights
4. USB 3.0 port
5. Drive bay door

## Drive Bays

The following figure shows the drive bays of ReadyNAS 524X.

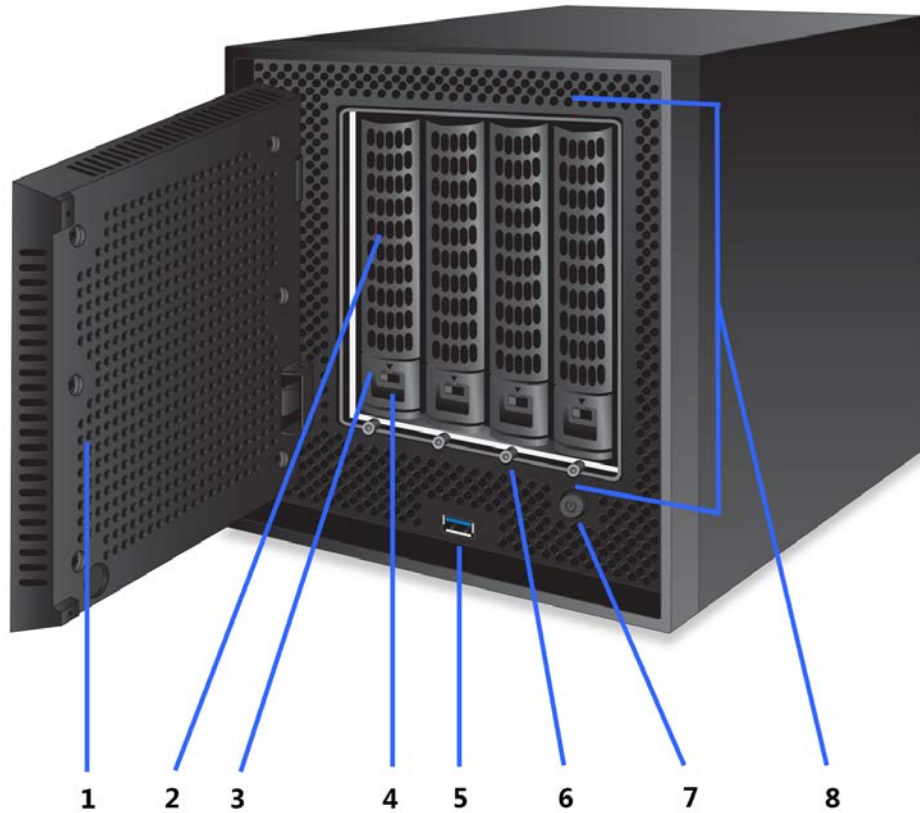

Figure 46. ReadyNAS 524X drive bays

1. Drive bay door
2. Disk tray handle
3. Disk tray release latch
4. Recessed disk tray handle lock
5. USB 3.0 port
6. Disk LED
7. Power button
8. Drive bays

## Rear Panel

The following figure shows the rear panel of the ReadyNAS 524X.

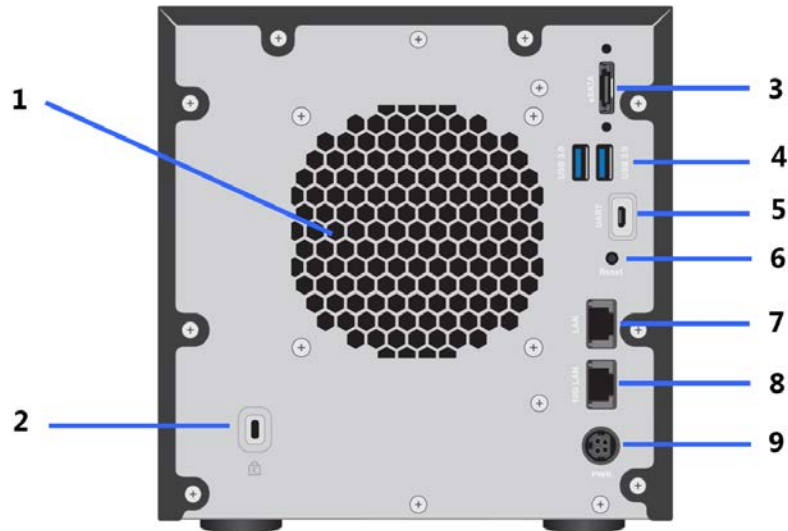

Figure 47. Rear panel ReadyNAS 524X

1. Exhaust fan
2. Kensington lock
3. eSATA port
4. USB 3.0 ports
5. Micro USB console connector (marked as UART)
6. Reset button
7. 1 GbE LAN port with LED status indicators
8. 10 GbE LAN port with LED status indicators
9. Power cable socket

## Status Information

You can obtain information about the status of your storage system by reviewing the indicators listed in the following table.

**Table 15. Indicator descriptions ReadyNAS 524X**

Indicator	Description
Front panel status display screen	Displays messages about the status of your storage system. Note that the status display screen goes to sleep to prevent burn-in. To wake the status display screen, press any button on the front panel. If the storage system reports an abnormal operation or error, the status display screen stays on.
Drive bay disk LEDs	A disk LED next to each drive bay indicates the status of the disk inside. The disk LEDs indicate these states: <ul data-bbox="500 751 1365 947" style="list-style-type: none"><li>• <b>Solid blue.</b> Power is on and the disk is operating normally.</li><li>• <b>Blinking blue.</b> The disk is active.</li><li>• <b>Solid red.</b> The disk was removed, failed, or is resynchronizing. See the display screen for details.</li><li>• <b>Off.</b> No disk is present.</li></ul>

**Table 15. Indicator descriptions ReadyNAS 524X (Continued)**

Indicator	Description
Rear panel 1G Ethernet LAN port LEDs	<p>Two LED status indicators are built into each 1G Ethernet port. One LED is a bicolor LED that can light solid amber or solid green and indicates the port speed. The other LED is green and indicates the link (solid green) and activity (blinking green). These LEDs indicate port speed and activity as follows:</p> <ul style="list-style-type: none"> <li>• <b>Bicolor LED green, green LED solid.</b> 1 Gbps connection speed, no activity.</li> <li>• <b>Bicolor LED green, green LED blinking.</b> 1 Gbps connection speed, activity.</li> <li>• <b>Bicolor LED amber, green LED solid.</b> 100 Mbps connection speed, no activity.</li> <li>• <b>Bicolor LED amber, green LED blinking.</b> 100 Mbps connection speed, activity.</li> <li>• <b>Bicolor LED off, green LED off.</b> Either no connection or 10 Mbps connection without activity.</li> <li>• <b>Bicolor LED off, green LED blinking.</b> 10 Mbps connection, activity.</li> </ul>
Rear panel 10G Ethernet LAN port LEDs	<p>Two LED status indicators are built into each 10G Ethernet port. One LED is a bicolor LED that can light solid amber or solid green and indicates the port speed. The other LED is green and indicates the link (solid green) and activity (blinking green). These LEDs indicate port speed and activity as follows:</p> <ul style="list-style-type: none"> <li>• <b>Bicolor LED green, green LED solid.</b> 1 Gbps connection speed, no activity.</li> <li>• <b>Bicolor LED green, green LED blinking.</b> 1 Gbps connection speed, activity.</li> <li>• <b>Bicolor LED amber, green LED solid.</b> 10 Gbps connection speed, no activity.</li> <li>• <b>Bicolor LED amber, green LED blinking.</b> 10 Gbps connection speed, activity.</li> <li>• <b>Bicolor LED off, green LED off.</b> No connection.</li> </ul>

## Power On and Shut Down

This section describes how to power on and shut down your system. If you must shut down the system, use one of the preferred shutdown methods whenever possible.

### Power On

When you connect the system to a power supply or the system recovers from a power outage, the system returns to its last state:

- If the system was powered on, the system automatically powers on again when the power supply is connected or power is restored.
- If the system was powered off, the system remains off when the power supply is connected or power is restored.

In this situation, press the **Power** button on the front panel of the system to power on the system.

### Preferred Shutdown

You can gracefully shut down your system by using the **Power** button or the ReadyNAS local admin page.

For information about how to gracefully shut down your system using the ReadyNAS local admin page, see the *ReadyNAS OS 6 Software Manual*, which is available at [netgear.com/support/product/ReadyNAS\\_OS\\_6](http://netgear.com/support/product/ReadyNAS_OS_6).

#### ▶ To gracefully shut down your system using the Power button:

1. If the status display screen is not lit, do the following:
  - a. Press the **Power** button on the front panel of the system.  
The status display screen wakes.
  - b. Press the **Power** button a second time.  
Instructions for graceful shutdown display on the status display screen.
  - c. Press the **Power** button a third time.  
The system shuts down gracefully.
  
2. If the status display screen is lit, do the following:
  - a. Press the **Power** button on the front panel of the system.  
Instructions for graceful shutdown display on the status display screen.
  - b. Press the **Power** button again.  
The system shuts down gracefully.

### Forced Shutdown

Perform a forced shutdown only if the storage system is not responding.

#### ▶ To perform a forced shutdown:

Press and hold the **Power** button on the front panel of the system for five seconds.  
The LEDs blink quickly and simultaneously to warn that power will be cut off forcibly.

The system shuts down.

### Boot Menu

Use the boot menu to restart or troubleshoot your ReadyNAS storage system. Your storage system has the following boot modes:

- **Normal.** Initiates a normal boot process, just like booting using the **Power** button.
- **Factory default.** Initiates a short disk test that takes approximately 2 minutes. After the disk test, a 10-minute time-out period begins, during which all LEDs blink simultaneously.



#### **WARNING:**

**The factory default reboot process resets the storage system to factory settings, erases all data, resets all defaults, and reformats the disk to X-RAID.**



## ReadyNAS OS 6 Desktop Storage Systems

- If you want to cancel the factory default process, power off the storage system before the 10-minute time-out ends. The system powers down safely without causing any data loss.
- If you want to reset the system to factory default settings, do not power off your system. After the 10-minute time-out period, the factory default process begins.

**Tip** To start the factory default process immediately, press the **OK** button during the 10-minute time-out period.

- **OS reinstall.** Reinstalls the firmware from the internal flash to the disks. Use the OS reinstall boot mode when the system crashes and corrupts some configuration files. OS reinstall boot mode also resets some settings on your storage system, such as IP settings and the administrator password, to defaults.
- **Tech support.** Boots into a low-level diagnostic mode. Use the tech support boot mode only when instructed to do so by a NETGEAR technical support representative.
- **Volume read only.** Mounts a volume as read-only. Use this option when you are attempting to rescue data off a disk during a disaster recovery.
- **Memory test.** Performs a memory test. The pass or fail result is reported on the status display screen.
- **Test disk.** Performs an offline full disk test. This process can take four hours or more, depending on the size of your disks. Any problems are reported in the system logs. For more information about viewing the system logs, see the *ReadyNAS OS 6 Software Manual*, which is available at [netgear.com/support/product/ReadyNAS\\_OS\\_6](http://netgear.com/support/product/ReadyNAS_OS_6).

### ▶ To access the boot menu:

1. Power off your storage system.
2. Using a straightened paper clip, press and hold the **Reset** button.
3. Press the **Power** button on the front panel of the system.  
The system powers on.
4. Continue to press the **Reset** button until the status display screen shows a boot menu message.
5. Use the **Up** and **Down** buttons on the front panel to scroll through boot mode options.  
The status display screen shows the current boot mode option.
6. When the status display screen shows the boot mode that you need, press the **OK** button to confirm your boot menu selection.  
The system boots in the selected boot mode.

This chapter provides an overview of the physical features of the ReadyNAS 526X and 626X and includes the following sections:

- *Front and Side Panels* on page 131
- *Drive Bays* on page 132
- *Rear Panel ReadyNAS 526X* on page 133
- *Rear Panel ReadyNAS 626X* on page 134
- *Status Information* on page 135
- *Power On and Shut Down* on page 136
- *Boot Menu* on page 137

## Front and Side Panels

The following figure shows the front and side panels of the ReadyNAS 526X and 626X.

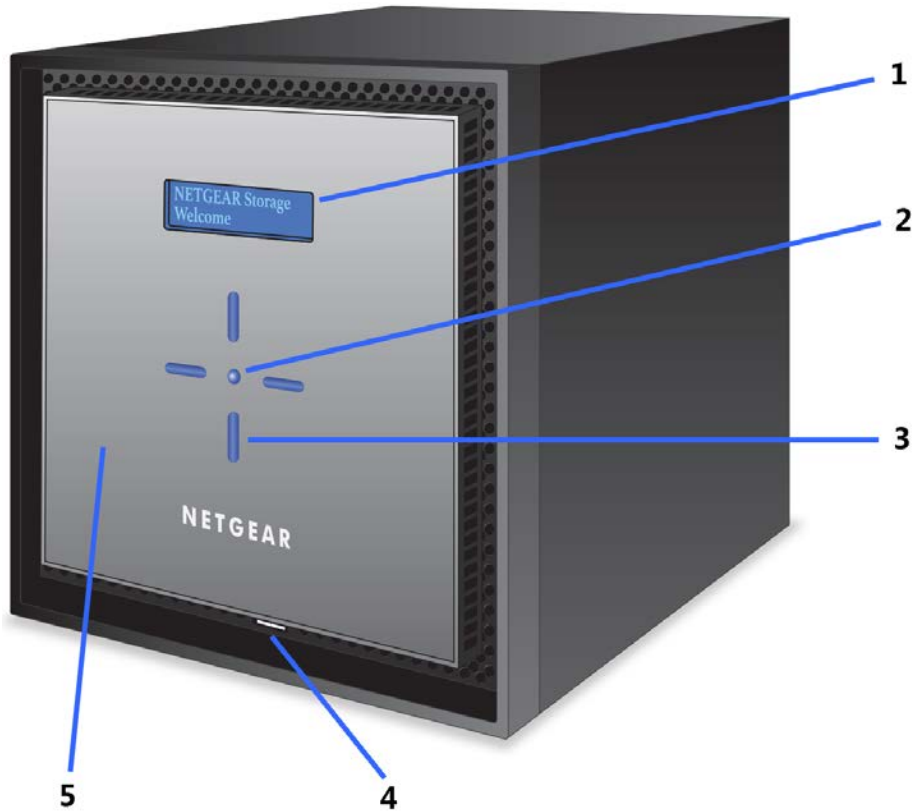

Figure 48. ReadyNAS 526X and 626X front and side panels

1. Status and menu display screen
2. OK button
3. Four buttons (Up, Down, Left, Right) and backlights
4. USB 3.0 port
5. Drive bay door

## Drive Bays

The following figure shows the drive bays of ReadyNAS 526X AND 626X.

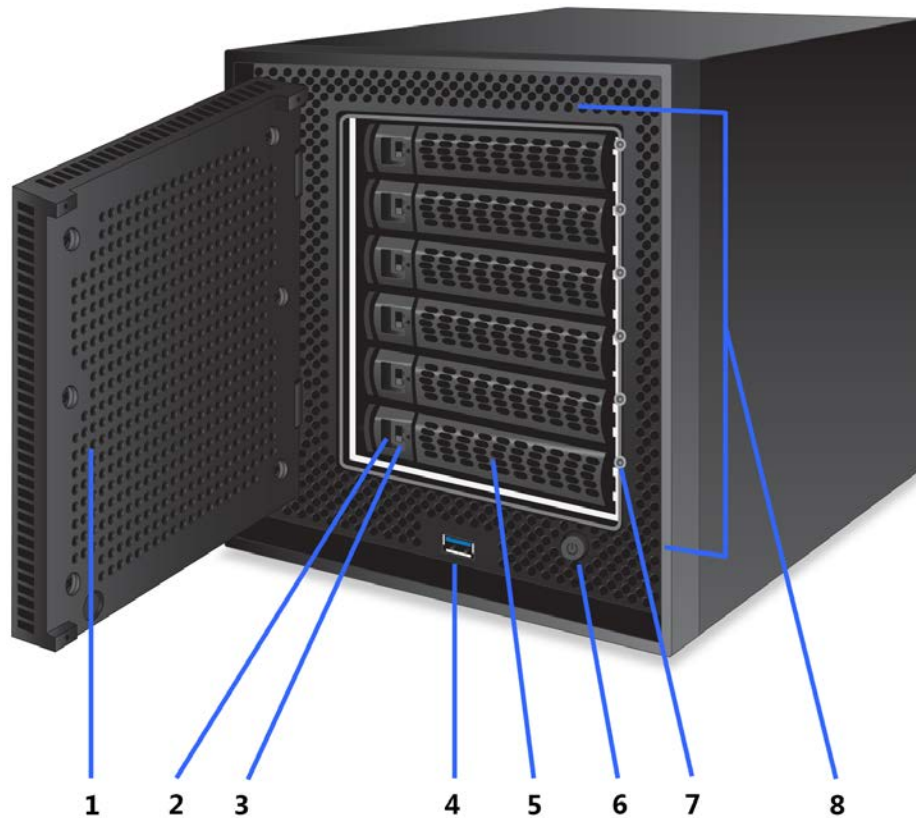

Figure 49. ReadyNAS 526X and 626X drive bays

1. Drive bay door
2. Disk tray release latch
3. Recessed disk tray handle lock
4. USB 3.0 port
5. Disk tray handle
6. Power button
7. Disk LED
8. Drive bays

## Rear Panel ReadyNAS 526X

The following figure shows the rear panel of the ReadyNAS 526X.

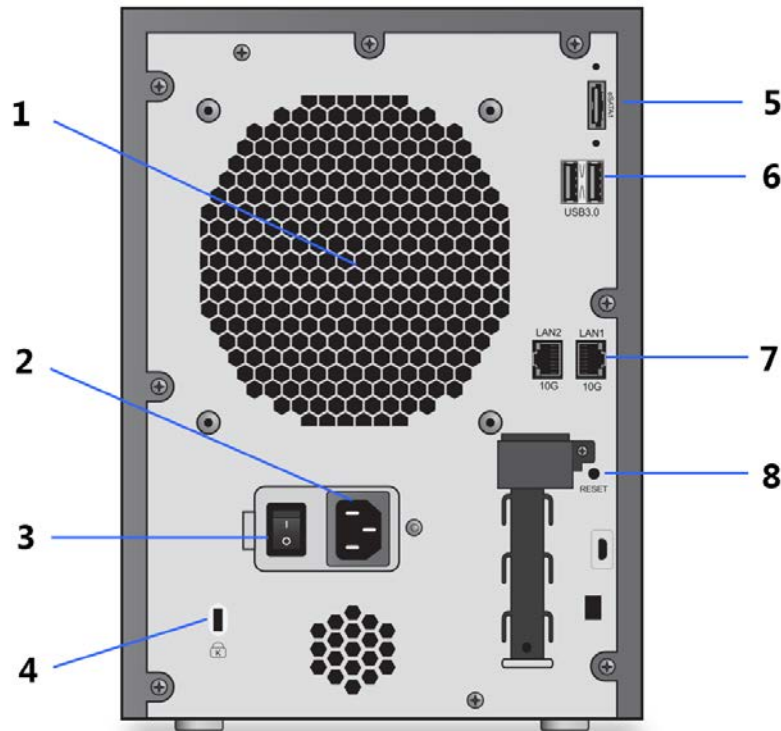

Figure 50. Rear panel ReadyNAS 526X

1. Exhaust fan
2. Power cable socket
3. Power switch
4. Kensington lock
5. eSATA port
6. USB 3.0 ports
7. 10 GbE LAN ports with LED status indicators
8. Reset button

## Rear Panel ReadyNAS 626X

The following figure shows the rear panel of the ReadyNAS 626X.

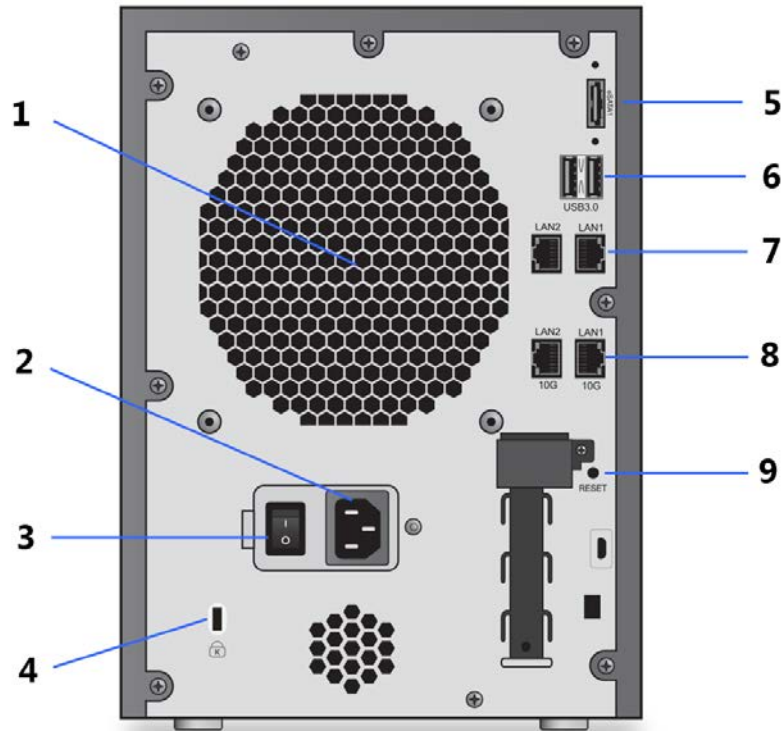

Figure 51. Rear panel ReadyNAS 626X

1. Exhaust fan
2. Power cable socket
3. Power switch
4. Kensington lock
5. eSATA port
6. USB 3.0 ports
7. 1 GbE LAN ports with LED status indicators
8. 10 GbE LAN ports with LED status indicators
9. Reset button

## Status Information

You can obtain information about the status of your storage system by reviewing the indicators listed in the following table.

**Table 16. Indicator descriptions ReadyNAS 526X and 626X**

Indicator	Description
Front panel status display screen	Displays messages about the status of your storage system. Note that the status display screen goes to sleep to prevent burn-in. To wake the status display screen, press any button on the front panel. If the storage system reports an abnormal operation or error, the status display screen stays on.
Drive bay disk LEDs	A disk LED next to each drive bay indicates the status of the disk inside. The disk LEDs indicate these states: <ul data-bbox="500 751 1369 947" style="list-style-type: none"><li>• <b>Solid blue.</b> Power is on and the disk is operating normally.</li><li>• <b>Blinking blue.</b> The disk is active.</li><li>• <b>Solid red.</b> The disk was removed, failed, or is resynchronizing. See the display screen for details.</li><li>• <b>Off.</b> No disk is present.</li></ul>

**Table 16. Indicator descriptions ReadyNAS 526X and 626X (Continued)**

Indicator	Description
<p>Model RN626X <i>only</i>: Rear panel 1G Ethernet LAN port LEDs</p>	<p>Two LED status indicators are built into each 1G Ethernet port. One LED is a bicolor LED that can light solid amber or solid green and indicates the port speed. The other LED is green and indicates the link (solid green) and activity (blinking green). These LEDs indicate port speed and activity as follows:</p> <ul style="list-style-type: none"> <li>• <b>Bicolor LED green, green LED solid.</b> 1 Gbps connection speed, no activity.</li> <li>• <b>Bicolor LED green, green LED blinking.</b> 1 Gbps connection speed, activity.</li> <li>• <b>Bicolor LED amber, green LED solid.</b> 100 Mbps connection speed, no activity.</li> <li>• <b>Bicolor LED off, green LED off.</b> Either no connection or 10 Mbps connection without activity.</li> <li>• <b>Bicolor LED off, green LED blinking.</b> 10 Mbps connection, activity.</li> </ul>
<p>Rear panel 10G Ethernet LAN port LEDs</p>	<p>Two LED status indicators are built into each 10G Ethernet port. One LED is a bicolor LED that can light solid amber or solid green and indicates the port speed. The other LED is green and indicates the link (solid green) and activity (blinking green). These LEDs indicate port speed and activity as follows:</p> <ul style="list-style-type: none"> <li>• <b>Bicolor LED green, green LED solid.</b> 1 Gbps connection speed, no activity.</li> <li>• <b>Bicolor LED green, green LED blinking.</b> 1 Gbps connection speed, activity.</li> <li>• <b>Bicolor LED amber, green LED solid.</b> 10 Gbps connection speed, no activity.</li> <li>• <b>Bicolor LED amber, green LED blinking.</b> 10 Gbps connection speed, activity.</li> <li>• <b>Bicolor LED off, green LED off.</b> No connection.</li> </ul>

## Power On and Shut Down

This section describes how to power on and shut down your system. If you must shut down the system, use one of the preferred shutdown methods whenever possible.

### Power On

When you connect the system to a power supply and the **Power** switch is in the On position or the system recovers from a power outage and the **Power** switch is in the On position, the following occurs:

- The system automatically powers on if you enabled the Wake on LAN (WoL) feature or scheduled the system to automatically power on or off.
- The system returns to its last state if the Wake on LAN (WoL) feature is disabled and you did not schedule the system to automatically power on or off:



- If the system was powered on, the system automatically powers on again when the power supply is connected or power is restored.
- If the system was powered off, the system remains off when the power supply is connected or power is restored.  
In this situation, press the **Power** button on the front panel of the system to power on the system.

## Preferred Shutdown

You can gracefully shut down your system by using the **Power** button or the ReadyNAS local admin page.

For information about how to gracefully shut down your system using the ReadyNAS local admin page, see the *ReadyNAS OS 6 Software Manual*, which is available at [netgear.com/support/product/ReadyNAS\\_OS\\_6](http://netgear.com/support/product/ReadyNAS_OS_6).

### ► To gracefully shut down your system using the Power button:

1. If the status display screen is not lit, do the following:
  - a. Press the **Power** button on the front panel of the system.  
The status display screen wakes.
  - b. Press the **Power** button a second time.  
Instructions for graceful shutdown display on the status display screen.
  - c. Press the **Power** button a third time.  
The system shuts down gracefully.
2. If the status display screen is lit, do the following:
  - a. Press the **Power** button on the front panel of the system.  
Instructions for graceful shutdown display on the status display screen.
  - b. Press the **Power** button again.  
The system shuts down gracefully.

## Forced Shutdown

Perform a forced shutdown only if the storage system is not responding.

### ► To perform a forced shutdown:

Press and hold the **Power** button on the front panel of the system for five seconds.  
The LEDs blink quickly and simultaneously to warn that power will be cut off forcibly.

The system shuts down.

## Boot Menu

Use the boot menu to restart or troubleshoot your ReadyNAS storage system. Your storage system has the following boot modes:

## ReadyNAS OS 6 Desktop Storage Systems

- **Normal.** Initiates a normal boot process, just like booting using the **Power** button.
- **Factory default.** Initiates a short disk test that takes approximately 2 minutes. After the disk test, a 10-minute time-out period begins, during which all LEDs blink simultaneously.



### **WARNING:**

The factory default reboot process resets the storage system to factory settings, erases all data, resets all defaults, and reformats the disk to X-RAID.

- If you want to cancel the factory default process, power off the storage system before the 10-minute time-out ends. The system powers down safely without causing any data loss.
- If you want to reset the system to factory default settings, do not power off your system. After the 10-minute time-out period, the factory default process begins.

**Tip** To start the factory default process immediately, press the **OK** button during the 10-minute time-out period.

- **OS reinstall.** Reinstalls the firmware from the internal flash to the disks. Use the OS reinstall boot mode when the system crashes and corrupts some configuration files. OS reinstall boot mode also resets some settings on your storage system, such as IP settings and the administrator password, to defaults.
- **Tech support.** Boots into a low-level diagnostic mode. Use the tech support boot mode only when instructed to do so by a NETGEAR technical support representative.
- **Volume read only.** Mounts a volume as read-only. Use this option when you are attempting to rescue data off a disk during a disaster recovery.
- **Memory test.** Performs a memory test. The pass or fail result is reported on the status display screen.
- **Test disk.** Performs an offline full disk test. This process can take four hours or more, depending on the size of your disks. Any problems are reported in the system logs. For more information about viewing the system logs, see the *ReadyNAS OS 6 Software Manual*, which is available at [netgear.com/support/product/ReadyNAS\\_OS\\_6](http://netgear.com/support/product/ReadyNAS_OS_6).

### ▶ **To access the boot menu:**

1. Power off your storage system.
2. Using a straightened paper clip, press and hold the **Reset** button.
3. Press the **Power** button on the front panel of the system.  
The system powers on.
4. Continue to press the **Reset** button until the status display screen shows a boot menu message.
5. Use the **Up** and **Down** buttons on the front panel to scroll through boot mode options.  
The status display screen shows the current boot mode option.
6. When the status display screen shows the boot mode that you need, press the **OK** button to confirm your boot menu selection.  
The system boots in the selected boot mode.

This chapter provides an overview of the physical features of the ReadyNAS 528X and 628X and includes the following sections:

- *Front and Side Panels* on page 140
- *Drive Bays* on page 141
- *Rear Panel ReadyNAS 528X* on page 142
- *Rear Panel ReadyNAS 628X* on page 143
- *Status Information* on page 144
- *Power On and Shut Down* on page 145
- *Boot Menu* on page 146

## Front and Side Panels

The following figure shows the front and side panels of the ReadyNAS 528X and 628X.

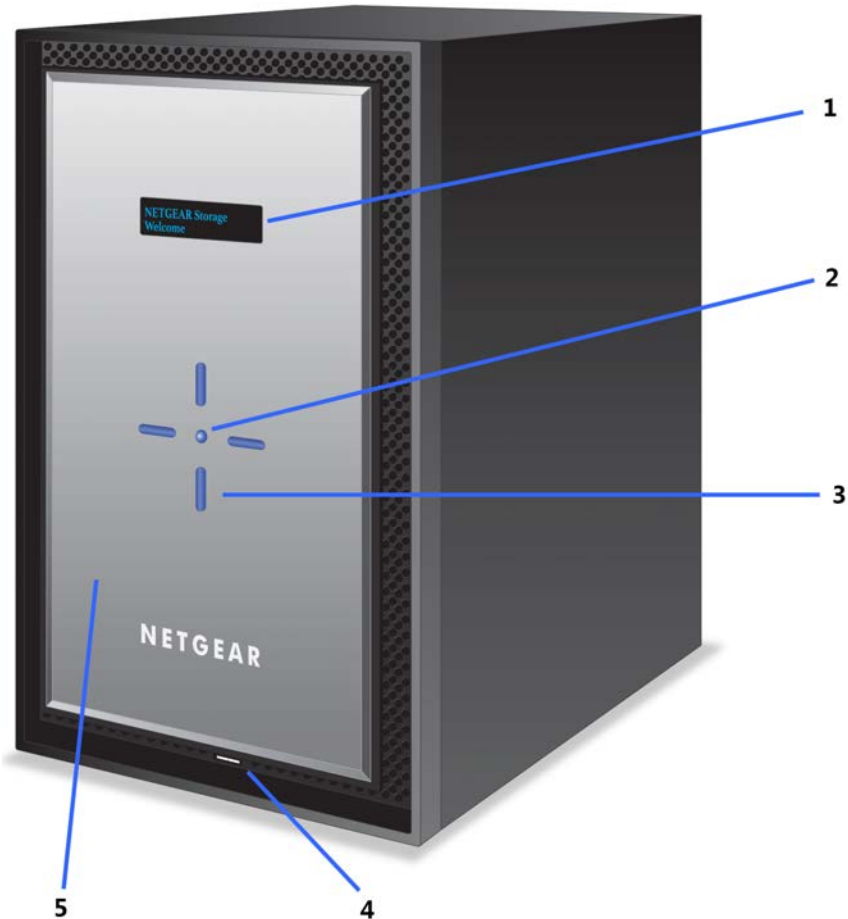

Figure 52. ReadyNAS 528X and 628X front and side panels

1. Status and menu display screen
2. OK button
3. Four buttons (Up, Down, Left, Right) and backlights
4. USB 3.0 port
5. Drive bay door

## Drive Bays

The following figure shows the drive bays of ReadyNAS 528X AND 628X.

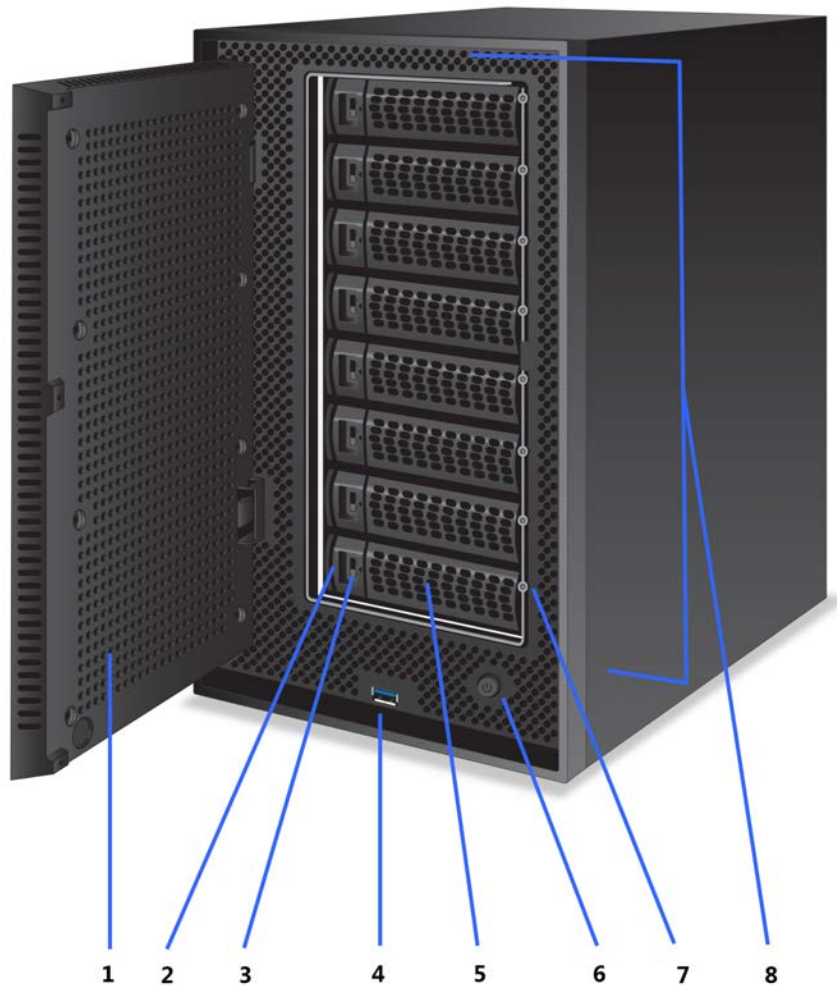

Figure 53. ReadyNAS 528X and 628X drive bays

1. Drive bay door
2. Disk tray release latch
3. Recessed disk tray handle lock
4. USB 3.0 port
5. Disk tray handle
6. Power button
7. Disk LED
8. Drive bays

## Rear Panel ReadyNAS 528X

The following figure shows the rear panel of the ReadyNAS 528X.

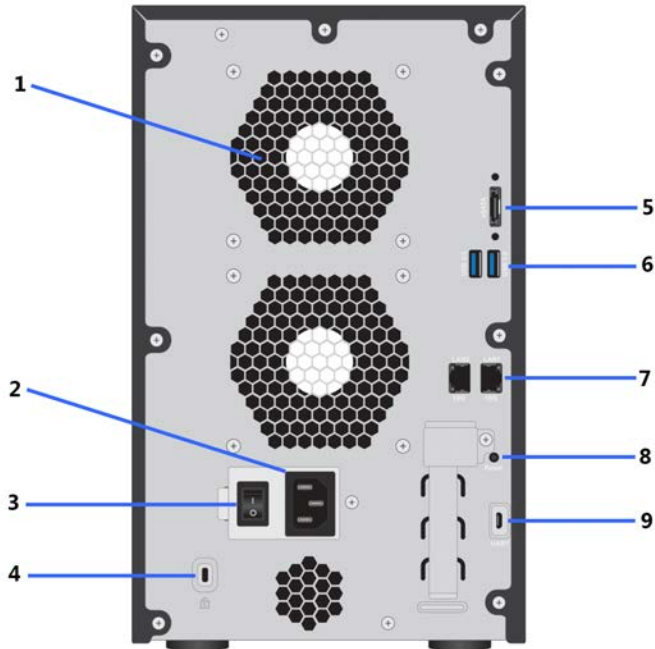

Figure 54. Rear panel ReadyNAS 528X

1. Exhaust fan
2. Power cable socket
3. Power switch
4. Kensington lock
5. eSATA port
6. USB 3.0 ports
7. 10 GbE LAN ports with LED status indicators
8. Reset button
9. Micro USB console connector (marked as UART)

## Rear Panel ReadyNAS 628X

The following figure shows the rear panel of the ReadyNAS 628X.

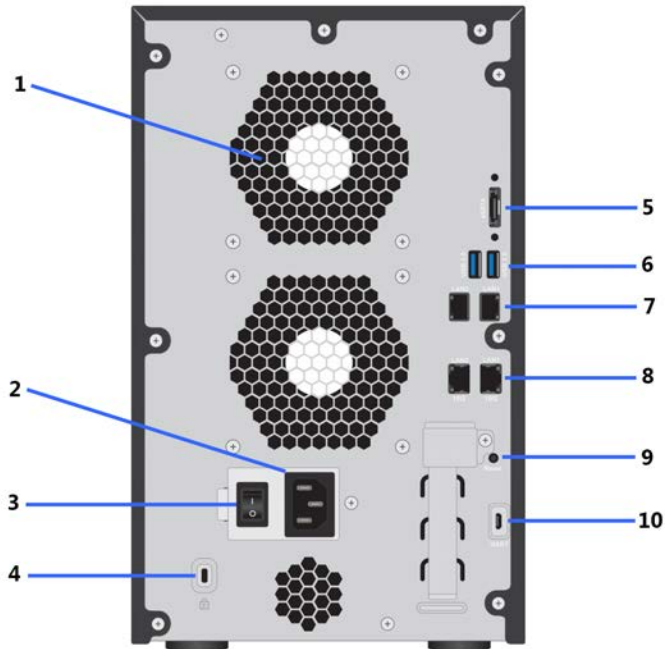

Figure 55. Rear panel ReadyNAS 628X

1. Exhaust fan
2. Power cable socket
3. Power switch
4. Kensington lock
5. eSATA port
6. USB 3.0 ports
7. 1 GbE LAN ports with LED status indicators
8. 10 GbE LAN ports with LED status indicators
9. Reset button
10. Micro USB console connector (marked as UART)

## Status Information

You can obtain information about the status of your storage system by reviewing the indicators listed in the following table.

**Table 17. Indicator descriptions ReadyNAS 528X and 628X**

Indicator	Description
Front panel status display screen	Displays messages about the status of your storage system. Note that the status display screen goes to sleep to prevent burn-in. To wake the status display screen, press any button on the front panel. If the storage system reports an abnormal operation or error, the status display screen stays on.
Drive bay disk LEDs	A disk LED next to each drive bay indicates the status of the disk inside. The disk LEDs indicate these states: <ul style="list-style-type: none"><li>• <b>Solid blue.</b> Power is on and the disk is operating normally.</li><li>• <b>Blinking blue.</b> The disk is active.</li><li>• <b>Solid red.</b> The disk was removed, failed, or is resynchronizing. See the display screen for details.</li><li>• <b>Off.</b> No disk is present.</li></ul>



**Table 17. Indicator descriptions ReadyNAS 528X and 628X (Continued)**

Indicator	Description
<p>Model RN628X <i>only</i>: Rear panel 1G Ethernet LAN port LEDs</p>	<p>Two LED status indicators are built into each 1G Ethernet port. One LED is a bicolor LED that can light solid amber or solid green and indicates the port speed. The other LED is green and indicates the link (solid green) and activity (blinking green). These LEDs indicate port speed and activity as follows:</p> <ul style="list-style-type: none"> <li>• <b>Bicolor LED green, green LED solid.</b> 1 Gbps connection speed, no activity.</li> <li>• <b>Bicolor LED green, green LED blinking.</b> 1 Gbps connection speed, activity.</li> <li>• <b>Bicolor LED amber, green LED solid.</b> 100 Mbps connection speed, no activity.</li> <li>• <b>Bicolor LED off, green LED off.</b> Either no connection or 10 Mbps connection without activity.</li> <li>• <b>Bicolor LED off, green LED blinking.</b> 10 Mbps connection, activity.</li> </ul>
<p>Rear panel 10G Ethernet LAN port LEDs</p>	<p>Two LED status indicators are built into each 10G Ethernet port. One LED is a bicolor LED that can light solid amber or solid green and indicates the port speed. The other LED is green and indicates the link (solid green) and activity (blinking green). These LEDs indicate port speed and activity as follows:</p> <ul style="list-style-type: none"> <li>• <b>Bicolor LED green, green LED solid.</b> 1 Gbps connection speed, no activity.</li> <li>• <b>Bicolor LED green, green LED blinking.</b> 1 Gbps connection speed, activity.</li> <li>• <b>Bicolor LED amber, green LED solid.</b> 10 Gbps connection speed, no activity.</li> <li>• <b>Bicolor LED amber, green LED blinking.</b> 10 Gbps connection speed, activity.</li> <li>• <b>Bicolor LED off, green LED off.</b> No connection.</li> </ul>

## Power On and Shut Down

This section describes how to power on and shut down your system. If you must shut down the system, use one of the preferred shutdown methods whenever possible.

### Power On

When you connect the system to a power supply and the **Power** switch is in the On position or the system recovers from a power outage and the **Power** switch is in the On position, the system returns to its last state:

- If the system was powered on, the system automatically powers on again when the power supply is connected or power is restored.
- If the system was powered off, the system remains off when the power supply is connected or power is restored.  
In this situation, press the **Power** button on the front panel of the system to power on the system.

### Preferred Shutdown

You can gracefully shut down your system by using the **Power** button or the ReadyNAS local admin page.

For information about how to gracefully shut down your system using the ReadyNAS local admin page, see the *ReadyNAS OS 6 Software Manual*, which is available at [netgear.com/support/product/ReadyNAS\\_OS\\_6](http://netgear.com/support/product/ReadyNAS_OS_6).

#### ▶ To gracefully shut down your system using the Power button:

1. If the status display screen is not lit, do the following:
  - a. Press the **Power** button on the front panel of the system.  
The status display screen wakes.
  - b. Press the **Power** button a second time.  
Instructions for graceful shutdown display on the status display screen.
  - c. Press the **Power** button a third time.  
The system shuts down gracefully.
2. If the status display screen is lit, do the following:
  - a. Press the **Power** button on the front panel of the system.  
Instructions for graceful shutdown display on the status display screen.
  - b. Press the **Power** button again.  
The system shuts down gracefully.

### Forced Shutdown

Perform a forced shutdown only if the storage system is not responding.

#### ▶ To perform a forced shutdown:

Press and hold the **Power** button on the front panel of the system for five seconds.  
The LEDs blink quickly and simultaneously to warn that power will be cut off forcibly.

The system shuts down.

### Boot Menu

Use the boot menu to restart or troubleshoot your ReadyNAS storage system. Your storage system has the following boot modes:

- **Normal.** Initiates a normal boot process, just like booting using the **Power** button.
- **Factory default.** Initiates a short disk test that takes approximately 2 minutes. After the disk test, a 10-minute time-out period begins, during which all LEDs blink simultaneously.



#### **WARNING:**

The factory default reboot process resets the storage system to factory settings, erases all data, resets all defaults, and reformats the disk to X-RAID.

## ReadyNAS OS 6 Desktop Storage Systems

- If you want to cancel the factory default process, power off the storage system before the 10-minute time-out ends. The system powers down safely without causing any data loss.
- If you want to reset the system to factory default settings, do not power off your system. After the 10-minute time-out period, the factory default process begins.

**Tip** To start the factory default process immediately, press the **OK** button during the 10-minute time-out period.

- **OS reinstall.** Reinstalls the firmware from the internal flash to the disks. Use the OS reinstall boot mode when the system crashes and corrupts some configuration files. OS reinstall boot mode also resets some settings on your storage system, such as IP settings and the administrator password, to defaults.
- **Tech support.** Boots into a low-level diagnostic mode. Use the tech support boot mode only when instructed to do so by a NETGEAR technical support representative.
- **Volume read only.** Mounts a volume as read-only. Use this option when you are attempting to rescue data off a disk during a disaster recovery.
- **Memory test.** Performs a memory test. The pass or fail result is reported on the status display screen.
- **Test disk.** Performs an offline full disk test. This process can take four hours or more, depending on the size of your disks. Any problems are reported in the system logs. For more information about viewing the system logs, see the *ReadyNAS OS 6 Software Manual*, which is available at [netgear.com/support/product/ReadyNAS\\_OS\\_6](http://netgear.com/support/product/ReadyNAS_OS_6).

### ▶ To access the boot menu:

1. Power off your storage system.
2. Using a straightened paper clip, press and hold the **Reset** button.
3. Press the **Power** button on the front panel of the system.  
The system powers on.
4. Continue to press the **Reset** button until the status display screen shows a boot menu message.
5. Use the **Up** and **Down** buttons on the front panel to scroll through boot mode options.  
The status display screen shows the current boot mode option.
6. When the status display screen shows the boot mode that you need, press the **OK** button to confirm your boot menu selection.  
The system boots in the selected boot mode.

This chapter provides an overview of the physical features of the ReadyNAS 716X and includes the following sections:

- *Front and Side Panels* on page 149
- *Drive Bays* on page 149
- *Rear Panel* on page 150
- *Status Information* on page 151
- *Power On and Shut Down* on page 153
- *Boot Menu* on page 154

## Front and Side Panels

The following figure shows the front and side panels of the ReadyNAS 716X.

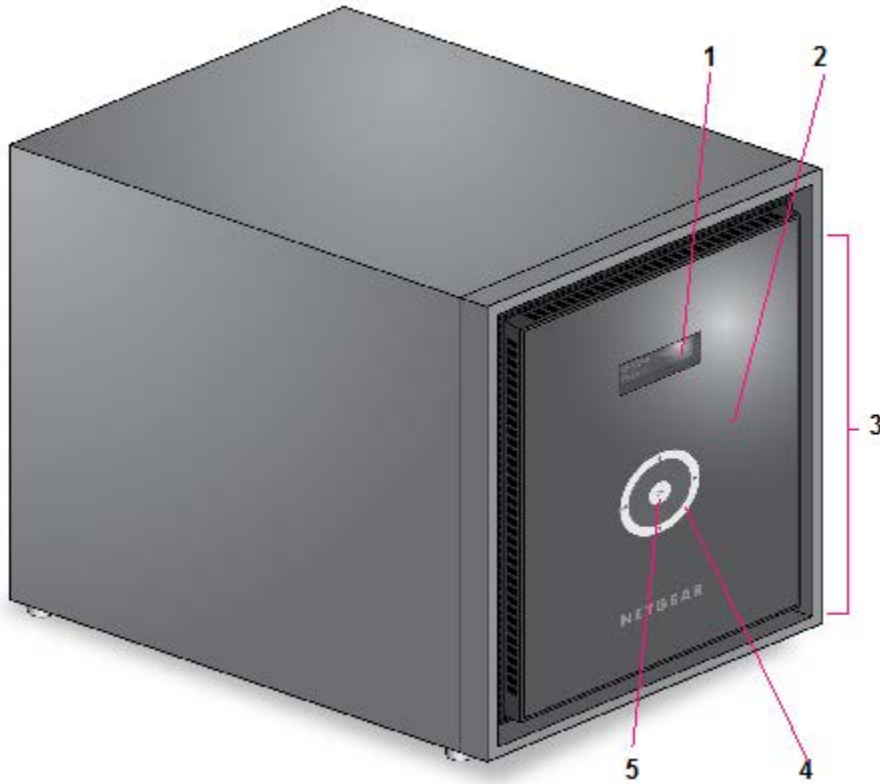

Figure 56. ReadyNAS 716X front and side panels

1. Status and menu display screen
2. Infrared remote receiver
3. Drive bay door
4. Touch pad and backlight
5. OK button

## Drive Bays

The following figure shows the drive bays of ReadyNAS 716X.

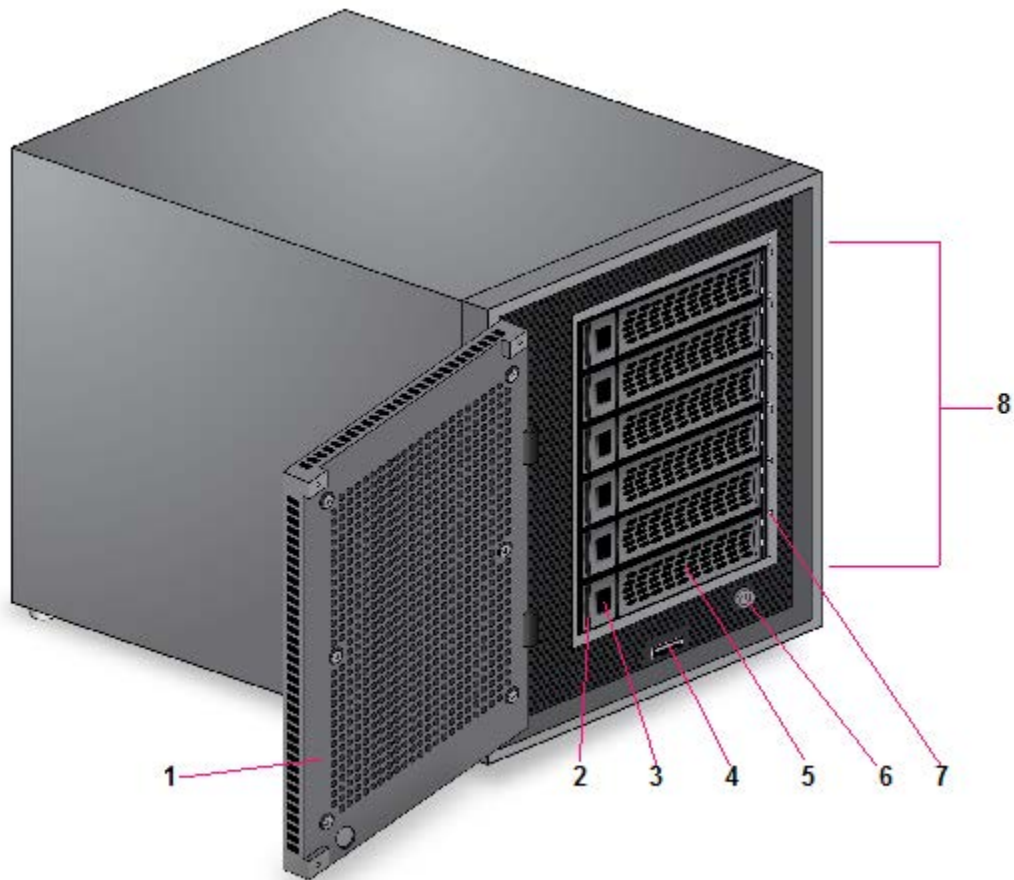

Figure 57. ReadyNAS 716X drive bays

1. Drive bay door
2. Disk tray release latch
3. Recessed disk tray handle lock
4. USB 2.0 port
5. Disk tray handle
6. Power button
7. Disk LED
8. Drive bays

## Rear Panel

The following figure shows the rear panel of ReadyNAS 716X.

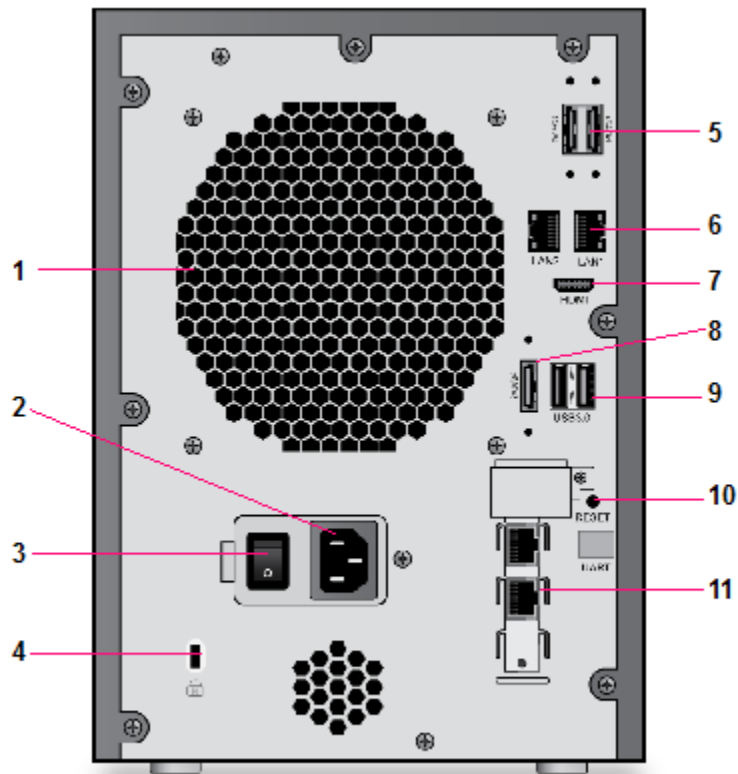

Figure 58. ReadyNAS 716X rear panel

1. Exhaust fan
2. Power cable socket
3. Power switch
4. Kensington lock
5. eSATA ports
6. 1 Gb LAN ports with LED status indicators
7. HDMI port
8. eSATA port
9. USB 3.0 ports
10. Reset button
11. 10 Gb LAN ports with LED status indicators

## Status Information

You can obtain information about the status of your storage system by reviewing the indicators listed in the following table.

**Table 18. ReadyNAS 716X indicator descriptions**

Indicator	Description
Disk LEDs	<p>A disk LED next to each drive bay indicates the status of the disk inside. The disk LEDs indicate these states:</p> <ul style="list-style-type: none"> <li>• <b>Solid blue.</b> Power is on and the disk is operating normally.</li> <li>• <b>Blinking blue.</b> The disk is active.</li> <li>• <b>Solid red.</b> The disk was removed, failed, or is resynchronizing. See the display screen for details.</li> <li>• <b>Off.</b> No disk is present.</li> </ul>
Rear panel Ethernet port LEDs (1 Gb)	<p>Two LED status indicators are built into this port, one green and one amber. They indicate port speed and activity as follows:</p> <ul style="list-style-type: none"> <li>• <b>Green on, amber off.</b> 1000 Mbps connection speed, no activity.</li> <li>• <b>Green blinking, amber off.</b> 1000 Mbps connection speed, activity.</li> <li>• <b>Green off, amber on.</b> 10 Mbps or 100 Mbps connection speed, no activity.</li> <li>• <b>Green off, amber blinking.</b> 10 Mbps or 100 Mbps connection speed, activity.</li> <li>• <b>Green off, amber off.</b> No connection.</li> </ul>



**Table 18. ReadyNAS 716X indicator descriptions (Continued)**

Indicator	Description
Rear panel Ethernet port LEDs (10 Gb)	<p>Two LED status indicators are built into this port. They indicate port speed and activity as follows:</p> <ul style="list-style-type: none"> <li>• LED 1 <ul style="list-style-type: none"> <li><b>Off.</b> No link.</li> <li><b>Solid green.</b> Linked.</li> <li><b>Blinking green.</b> Activity.</li> </ul> </li> <li>• LED 2 <ul style="list-style-type: none"> <li><b>Solid green.</b> 10 GbE.</li> <li><b>Solid yellow.</b> 1 GbE.</li> <li><b>Off.</b> 100 Mbps.</li> </ul> </li> </ul>
Status display screen	<p>Displays messages about the status of your storage system. Note that the status display screen goes to sleep to prevent burn-in. To wake the status display screen, activate the proximity sensor, press the touch pad, press the <b>OK</b> button, or press the <b>Power</b> button once. If the storage system reports an abnormal operation or error, the status display screen stays on.</p>

## Power On and Shut Down

This section describes how to power on and shut down your system. If you must shut down the system, use one of the preferred shutdown methods whenever possible.

### Power On

When you connect the system to a power supply and the **Power** switch is in the On position or the system recovers from a power outage and the **Power** switch is in the On position, the following occurs:

- The system automatically powers on if you enabled the Wake on LAN (WoL) feature or scheduled the system to automatically power on or off.
- The system returns to its last state if the Wake on LAN (WoL) feature is disabled and you did not schedule the system to automatically power on or off:

- If the system was powered on, the system automatically powers on again when the power supply is connected or power is restored.
- If the system was powered off, the system remains off when the power supply is connected or power is restored.  
In this situation, press the **Power** button on the front panel of the system to power on the system.

### Preferred Shutdown

You can gracefully shut down your system by using the **Power** button or the ReadyNAS local admin page.

For information about how to gracefully shut down your system using the ReadyNAS local admin page, see the *ReadyNAS OS 6 Software Manual*, which is available at [netgear.com/support/product/ReadyNAS\\_OS\\_6](http://netgear.com/support/product/ReadyNAS_OS_6).

#### ► To gracefully shut down your system using the Power button:

1. If the status display screen is not lit, do the following:
  - a. Press the **Power** button on the front panel of the system.  
The status display screen wakes.
  - b. Press the **Power** button a second time.  
Instructions for graceful shutdown display on the status display screen.
  - c. Press the **Power** button a third time.  
The system shuts down gracefully.
2. If the status display screen is lit, do the following:
  - a. Press the **Power** button on the front panel of the system.  
Instructions for graceful shutdown display on the status display screen.
  - b. Press the **Power** button again.  
The system shuts down gracefully.

### Forced Shutdown

Perform a forced shutdown only if the storage system is not responding.

#### ► To perform a forced shutdown:

- Press and hold the **Power** button on the front panel of the system for five seconds.  
The LEDs blink quickly and simultaneously to warn that power will be cut off forcibly.

The system shuts down.

### Boot Menu

Use the boot menu to restart or troubleshoot your ReadyNAS storage system. Your storage system has the following boot modes:

## ReadyNAS OS 6 Desktop Storage Systems

- **Normal.** Initiates a normal boot process, just like booting using the **Power** button.
- **Factory default.** Initiates a short disk test that takes approximately 2 minutes. After the disk test, a 10-minute time-out period begins, during which all LEDs blink simultaneously.



### **WARNING:**

**The factory default reboot process resets the storage system to factory settings, erases all data, resets all defaults, and reformats the disk to X-RAID.**

- If you want to cancel the factory default process, power off the storage system before the 10-minute time-out ends. The system powers down safely without causing any data loss.
- If you want to reset the system to factory default settings, do not power off your system. After the 10-minute time-out period, the factory default process begins.

**Tip** To start the factory default process immediately, press the **OK** button during the 10-minute time-out period.

- **OS reinstall.** Reinstalls the firmware from the internal flash to the disks. Use the OS reinstall boot mode when the system crashes and corrupts some configuration files. OS reinstall boot mode also resets some settings on your storage system, such as Internet protocol settings and the administrator password, to defaults.
- **Tech support.** Boots into a low-level diagnostic mode. Use the tech support boot mode only when instructed to do so by a NETGEAR technical support representative.
- **Volume read only.** Mounts a volume as read-only. Use this option when you are attempting to rescue data off a disk during a disaster recovery.
- **Memory test.** Performs a memory test. The pass or fail result is reported on the status display screen.
- **Test disk.** Performs an offline full disk test. This process can take four hours or more, depending on the size of your disks. Any problems are reported in the system logs. For more information about viewing the system logs, see the *ReadyNAS OS 6 Software Manual*, which is available at [netgear.com/support/product/ReadyNAS\\_OS\\_6](http://netgear.com/support/product/ReadyNAS_OS_6).

### ▶ **To access the boot menu:**

1. Power off your storage system.
2. Using a straightened paper clip, press and hold the **Reset** button.
3. Press the **Power** button on the front panel of the system.  
The system powers on.
4. Continue to press the **Reset** button until the status display screen shows a boot menu message.
5. Use the arrows on the touch pad to scroll through boot mode options.  
The status display screen shows the current boot mode option.
6. When the status display screen shows the boot mode that you need, press the **OK** button to confirm your boot menu selection.  
The system boots in the selected boot mode.

This chapter provides an overview of the physical features of the EDA 500 and includes the following sections:

- *Front and Side Panels* on page 157
- *Drive Bays* on page 157
- *Rear Panel* on page 158
- *Status Information* on page 159
- *Power On and Shut Down* on page 160

---

**Note** The EDA 500 disk trays are slightly different from the standard trays. Use only EDA 500 disk trays with the EDA 500. For more information about the EDA 500 disk trays, see *EDA 500 Disk Tray* on page 164.

---

A ReadyNAS cannot boot using the disks in an EDA 500. All disks in a RAID volume must be either in a ReadyNAS or in an EDA 500. A RAID volume cannot combine disks in a ReadyNAS with disks in an EDA 500.

You can add an EDA 500 to a ReadyNAS while the ReadyNAS is running, but you cannot remove the EDA while the ReadyNAS is running.

You can add and remove disks while an EDA 500 is in operation (hot swap). If an added disk has data on it, the data shows as an inactive volume. You need to destroy inactive volumes, which destroys all data in the volume, and create new volumes, before the space is available for use by the ReadyNAS.

## Front and Side Panels

The following figure shows the front and side panels of EDA 500.



Figure 59. EDA 500 front and side panels

1. Power LED
2. eSATA LED
3. Volume LED
4. Alert LED
5. Drive bay door

## Drive Bays

The following figure shows the drive bays of EDA 500.

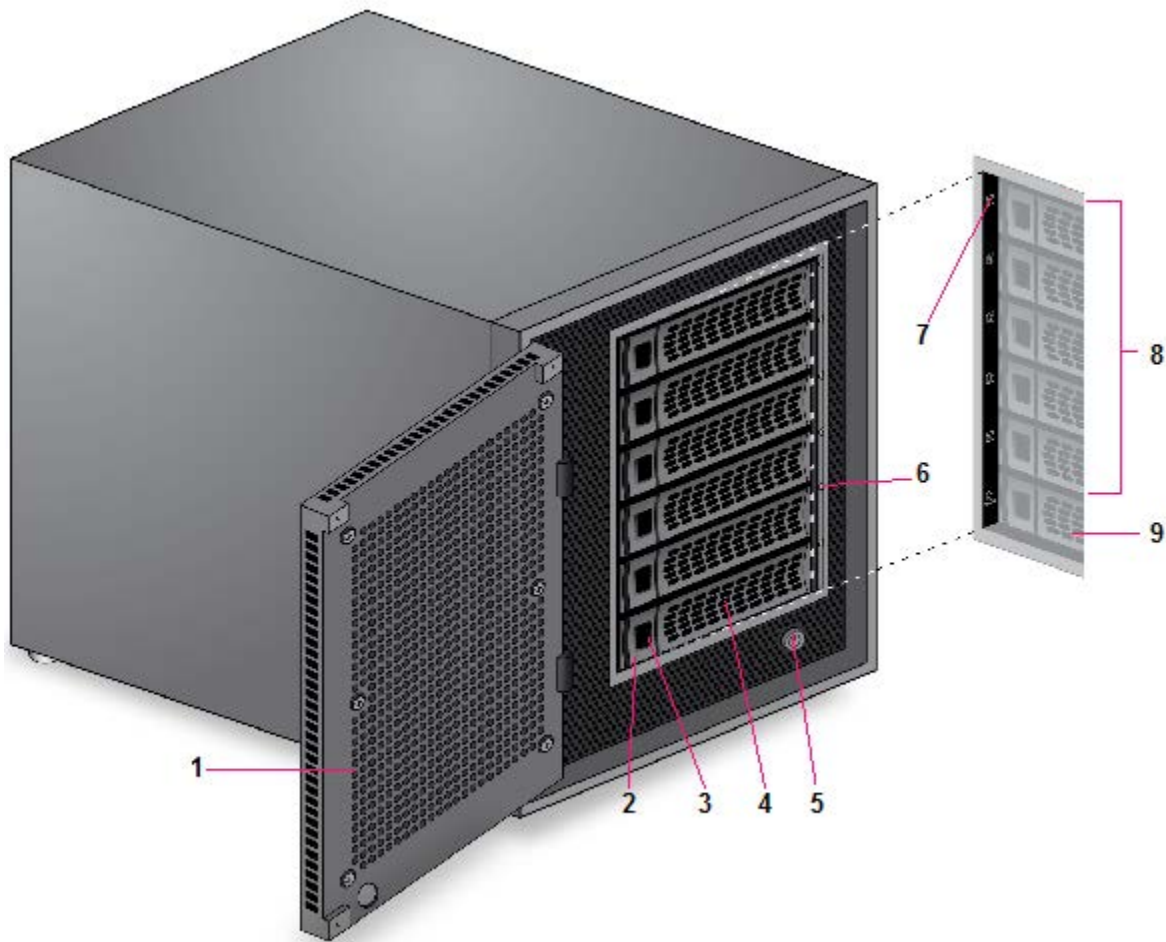

Figure 60. EDA 500 drive bays

1. Drive bay door
2. Disk tray release latch
3. Recessed disk tray handle lock
4. Disk tray handle
5. Power button
6. Disk LED
7. Disk label
8. Active drive bays
9. Cold spare drive bay

## Rear Panel

The following figure shows the rear panel of EDA 500.

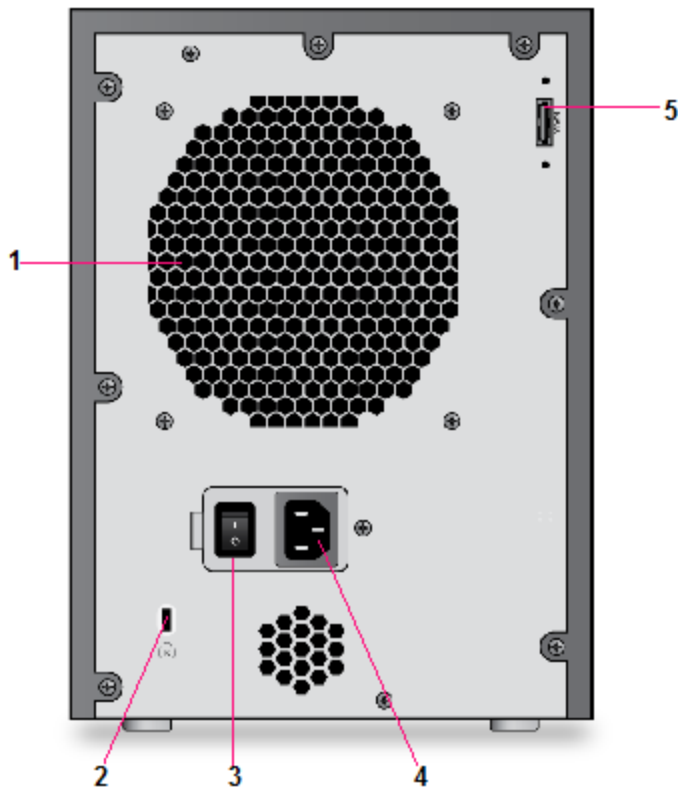

Figure 61. EDA 500 rear panel

1. Exhaust fan
2. Kensington lock
3. Power switch
4. Power cable socket
5. eSATA port

## Status Information

You can obtain information about the status of your storage system by reviewing the indicators listed in the following table.

**Table 19. EDA 500 indicator descriptions**

Indicator	Description
Power LED	The Power LED indicates these states: <ul style="list-style-type: none"> <li>• <b>On.</b> Powered on.</li> <li>• <b>Off.</b> Powered off.</li> </ul>
eSATA LED	The eSATA LED indicates these states: <ul style="list-style-type: none"> <li>• <b>On.</b> The SATA link is established between the EDA 500 and a host.</li> <li>• <b>Off.</b> The SATA link is not established.</li> </ul>
Volume LED	The Volume LED indicates these states: <ul style="list-style-type: none"> <li>• <b>On.</b> The data volume or volumes are mounted by a host.</li> <li>• <b>Off.</b> The data volume or volumes are not mounted. You can safely disconnect the eSATA cable.</li> </ul>
Alert LED	The Alert LED indicates these states: <ul style="list-style-type: none"> <li>• <b>On.</b> The system needs attention. Use the local admin page to determine the problem. For more information, see the <i>ReadyNAS OS 6 Software Manual</i>, which is available at <a href="http://netgear.com/support/product/ReadyNAS_OS_6">netgear.com/support/product/ReadyNAS_OS_6</a>.</li> <li>• <b>Off.</b> The system is healthy.</li> </ul>
Disk LEDs	A disk LED next to each active drive bay indicates the status of the disk inside. (The cold spare drive bay has no LED.) The disk LEDs indicate these states: <ul style="list-style-type: none"> <li>• <b>Solid blue.</b> Power is on and the disk is operating normally.</li> <li>• <b>Blinking blue.</b> The disk is active.</li> <li>• <b>Solid red.</b> The disk was removed, failed, or is resynchronizing. See the display screen for details.</li> <li>• <b>Off.</b> No disk is present.</li> </ul>

## Power On and Shut Down

This section describes how to power on and shut down your system. If you must shut down the system, use the preferred shutdown method whenever possible.

### Power On

When the system is connected to a power supply and the **Power** switch is in the On position, the system automatically powers on.



When connected to a host that is powered on, the EDA 500 automatically powers on. The EDA 500 detects a powered-on host through the eSATA link.

You can also power on the system by pressing the **Power** button on the front panel of the system.

### Preferred Shutdown

If possible, always unmount the EDA 500 volumes from the host before shutting down the EDA 500.

Use the ReadyNAS local admin page to gracefully shut down the EDA 500. For information about how to gracefully shut down the EDA 500 using the ReadyNAS local admin page, see the *ReadyNAS OS 6 Software Manual*, which is available at [netgear.com/support/product/ReadyNAS\\_OS\\_6](http://netgear.com/support/product/ReadyNAS_OS_6).

### Forced Shutdown

Perform a forced shutdown only if the storage system is not responding.

#### ▶ To perform a forced shutdown:

- Flip the **Power** switch on the back panel of the system to the Off position.

This chapter describes how to reformat, add, and replace disks in your ReadyNAS OS 6 storage system.

For information about configuring disks on your storage system, see the ReadyNAS OS 6 Software Manual, which is available at [netgear.com/support/product/ReadyNAS\\_OS\\_6](http://netgear.com/support/product/ReadyNAS_OS_6).

This chapter includes the following topics:

- *Disk Trays* on page 163
- *Supported Disks* on page 164
- *Previously Formatted Disks* on page 165
- *Add a Disk* on page 166
- *Replace a Disk* on page 175

## Disk Trays

All systems except the EDA 500 use standard disk trays. The EDA 500 comes with its own special disk trays. This section describes both the standard and EDA 500 disk trays.

---

**Note** For some disks, first remove the plastic mounting bracket from the disk tray before you mount the disk to the disk tray. After you mount the disk to the disk tray, use the screws to secure the disk to the disk tray.

---

### Standard Disk Tray

The following figure shows the features of the standard disk tray. This disk tray is used in all systems except the EDA 500. For information about the EDA 500 disk tray, see [EDA 500 Disk Tray](#) on page 164.

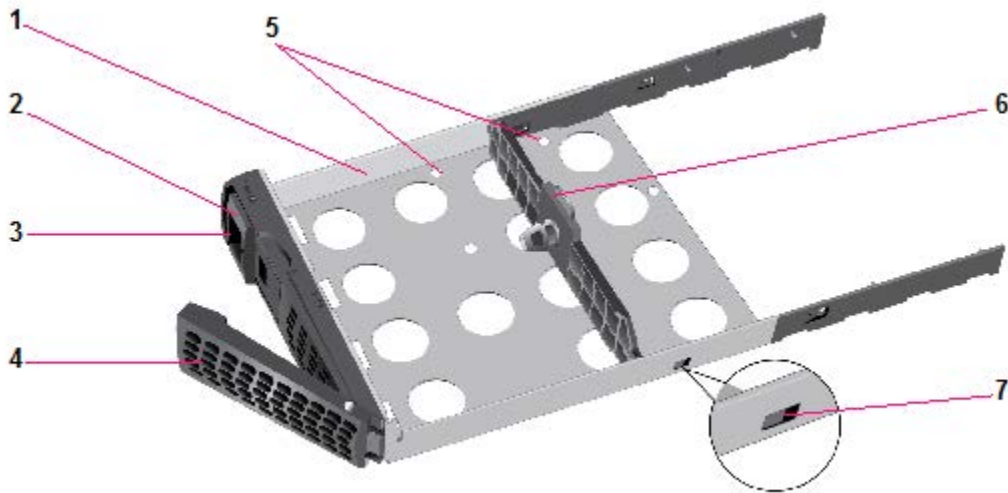

Figure 62. Standard disk tray

1. Disk tray
2. Disk tray release latch
3. Recessed disk tray handle lock
4. Disk tray handle
5. Disk screw holes
6. Mounting bracket
7. Bracket lock

**IMPORTANT:**

To maintain adequate airflow, make sure that all disk trays remain in the drive bays, even if no disk is installed in the tray. Do not use standard disk trays with the EDA 500. Use only EDA 500 disk trays with the EDA 500.

## EDA 500 Disk Tray

The following figure shows the features of the EDA 500 disk tray. The EDA 500 disk tray and the standard disk tray are the same, except for the EMI shielding on the EDA 500 disk tray. For this reason, use only EDA 500 disk trays with the EDA 500.

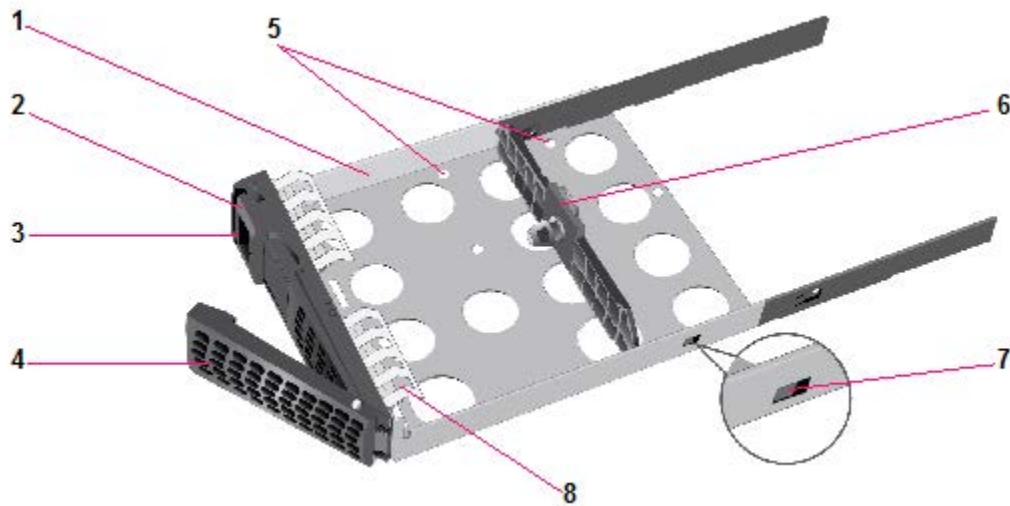

Figure 63. EDA 500 disk tray

1. Disk tray
2. Disk tray release latch
3. Recessed disk tray handle lock
4. Disk tray handle
5. Disk screw holes
6. Mounting bracket
7. Bracket lock
8. EMI shielding

**IMPORTANT:**

**Use only EDA 500 disk trays with the EDA 500. Do not use standard disk trays with the EDA 500.**

**To maintain adequate airflow, make sure that all disk trays remain in the drive bays, even if no disk is installed in the tray.**

## Supported Disks

Use only supported SATA hard disk drives (HDD) or solid state drives (SSD) in your ReadyNAS storage system. If you use disks that are not supported, NETGEAR technical support will not provide assistance. For a list of supported disks, see the NETGEAR Hardware Compatibility List at [netgear.com/readynas-hcl](http://netgear.com/readynas-hcl).

# Previously Formatted Disks

This section describes how to use previously formatted disks with your ReadyNAS OS 6 storage system. Previously formatted disks must appear on the NETGEAR Hardware Compatibility List, which is available at [netgear.com/readynas-hcl](http://netgear.com/readynas-hcl).

## Reformat Previously Formatted Disks

If you want to use disks that were previously formatted for an operating system other than ReadyNAS OS 6 (for example, Windows or RAIDiator), you must reformat the disks.

If you want to use disks from another ReadyNAS OS 6 storage system, see [Migrate a Volume](#) on page 166.

---

**Note** If you try to use previously formatted disks in a system that does not contain any other disks, the system does not boot and ReadyCLOUD does not discover your device. If you use RAIDar to discover your device, RAIDar displays a "Corrupt Root" error message.

If you try to use previously formatted disks in a system that already contains usable disks, the system does not reformat or use the previously formatted disks. Any data on the previously formatted disk remains intact.

---

The following instructions describe how to reformat previously formatted disks in a ReadyNAS OS 6 system. This procedure assumes that the system does not contain any other disks.

### ► To reformat previously formatted disks with a diskless ReadyNAS OS 6 system:

1. Gracefully shut down the storage system.  
For information about how to gracefully shut down your system, see the Preferred Shutdown section of the chapter that describes your system.
2. Install the disks.  
For more information, see [Add a Disk](#) on page 166.
3. Reset the system to its factory default settings.



**WARNING:**

**This process erases all data and reformats all disks into a single X-RAID volume. If you want to preserve the data on the disks, you must back up the data to an external drive before using the disks in your ReadyNAS storage system.**

For information about how to reset the system to its factory default settings, see the Boot Menu section of the chapter that describes your system.

The disk is reformatted and becomes available for use with your ReadyNAS OS 6 storage system.

### Migrate a Volume

You can migrate a volume from one ReadyNAS OS 6 storage system to another, as long as you migrate every disk in the volume. For example, if you want to migrate a volume that contains two disks, you must add both disks to the new system. If you add only part of a volume to the new system, the system recognizes the disk as a degraded volume.

If your ReadyNAS storage system is operating with one or more disks, you can add disks while the system is running. The new system recognizes the migrated volume and its data. For more information about adding a disk while the system is running, see [Add a Disk](#) on page 166.

If your ReadyNAS storage system does not have any disks installed, perform the following procedure.

#### ► To migrate a volume to a diskless ReadyNAS OS 6 system:

1. Gracefully shut down the new (diskless) storage system.  
For information about how to gracefully shut down your system, see the Preferred Shutdown section of the chapter that describes your system.
2. Remove each disk in the volume from the old system.
3. Install each disk in the volume into the new storage system.  
For more information, see [Add a Disk](#) on page 166.
4. Turn on the new system by pressing the **Power** button.  
The new system recognizes the migrated volume and its data.

### Add a Disk

You can add a 3.5-inch hard disk drive, a 2.5-inch hard disk drive, or a 2.5-inch solid state drive to an empty drive bay.

If you want to add a previously formatted disk to your storage system, see the instructions in [Previously Formatted Disks](#) on page 165.

#### Add a 3.5-Inch Disk

##### ► To add a 3.5-inch hard disk drive (HDD):

1. Determine whether you must shut down your system:
  - If you are adding disks to a diskless system, gracefully shut down the system.  
For information about how to gracefully shut down your system, see the Preferred Shutdown section of the chapter that describes your system.
  - If your system is operating with one or more disks, you can add disks while the system is running. You do not need to shut down the system.
2. If necessary, slide the recessed handle lock to the unlocked position.

3. Press the disk tray release latch.

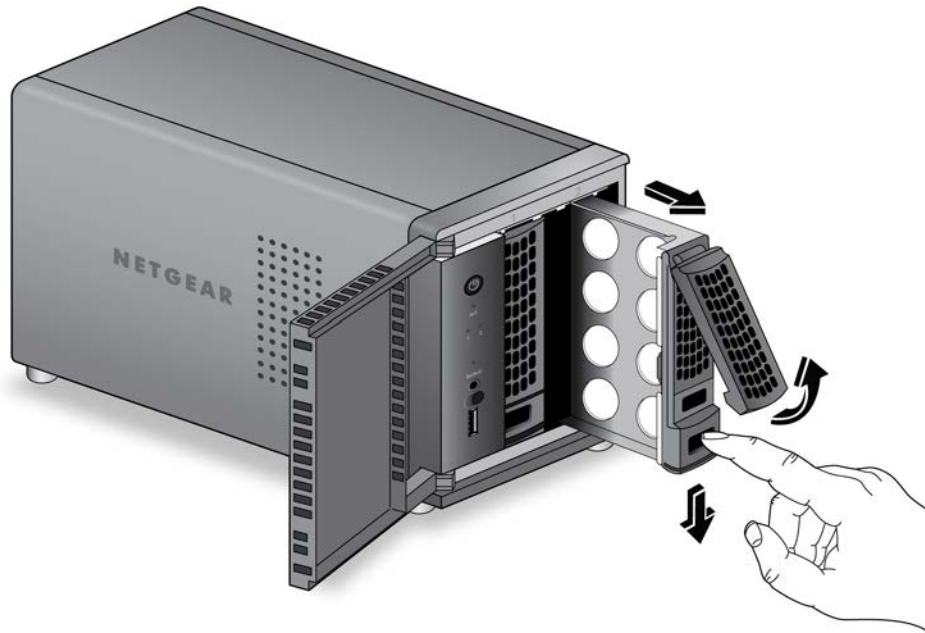

The disk tray handle pops out.

4. Pull out the disk tray.
5. Separate the mounting bracket from the disk tray:
  - a. Press and hold the disk tray release latch.
  - b. While holding the release latch, use your other hand to pull out one end of the mounting bracket and then the other until the ends extend slightly past the disk tray.

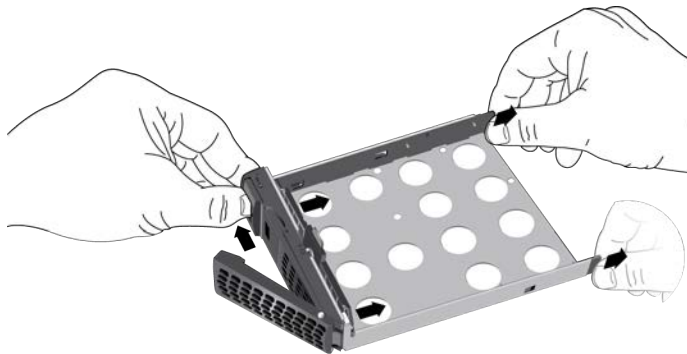

## ReadyNAS OS 6 Desktop Storage Systems

Make sure that the ends of the mounting bracket are even with each other.

- c. Slide the bracket down the disk tray, keeping both sides of the bracket even with each other.

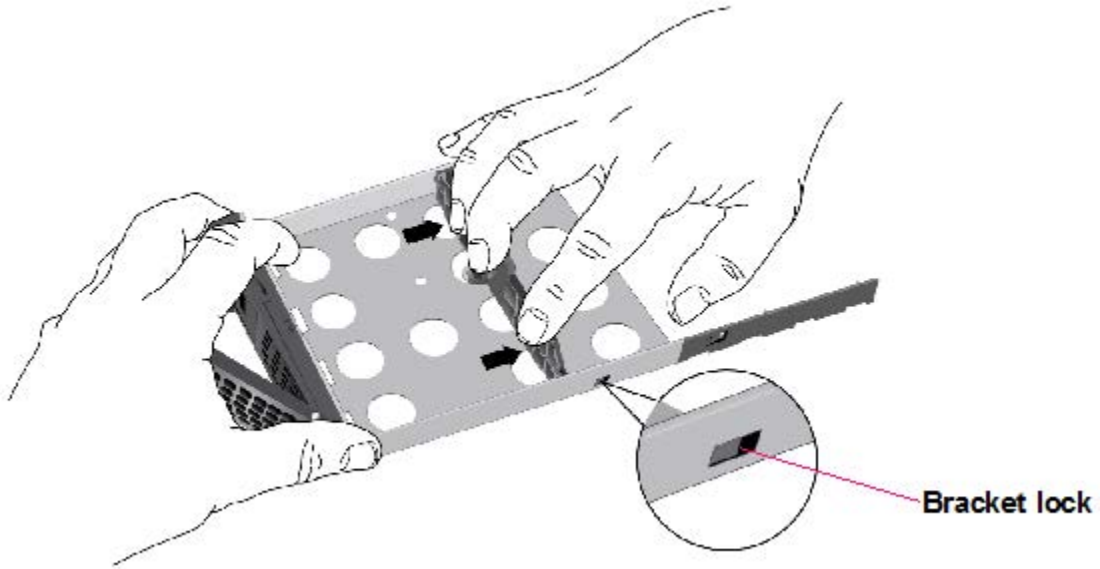

The mounting bracket stops when it hits the bracket lock.

The bracket lock prevents the mounting bracket from sliding all the way off the disk tray.

6. Attach the new HDD to the mounting bracket.



## ReadyNAS OS 6 Desktop Storage Systems

Make sure that the HDD mounting holes are aligned with the bracket's mounting posts and that the HDD connectors face the interior of the disk tray.

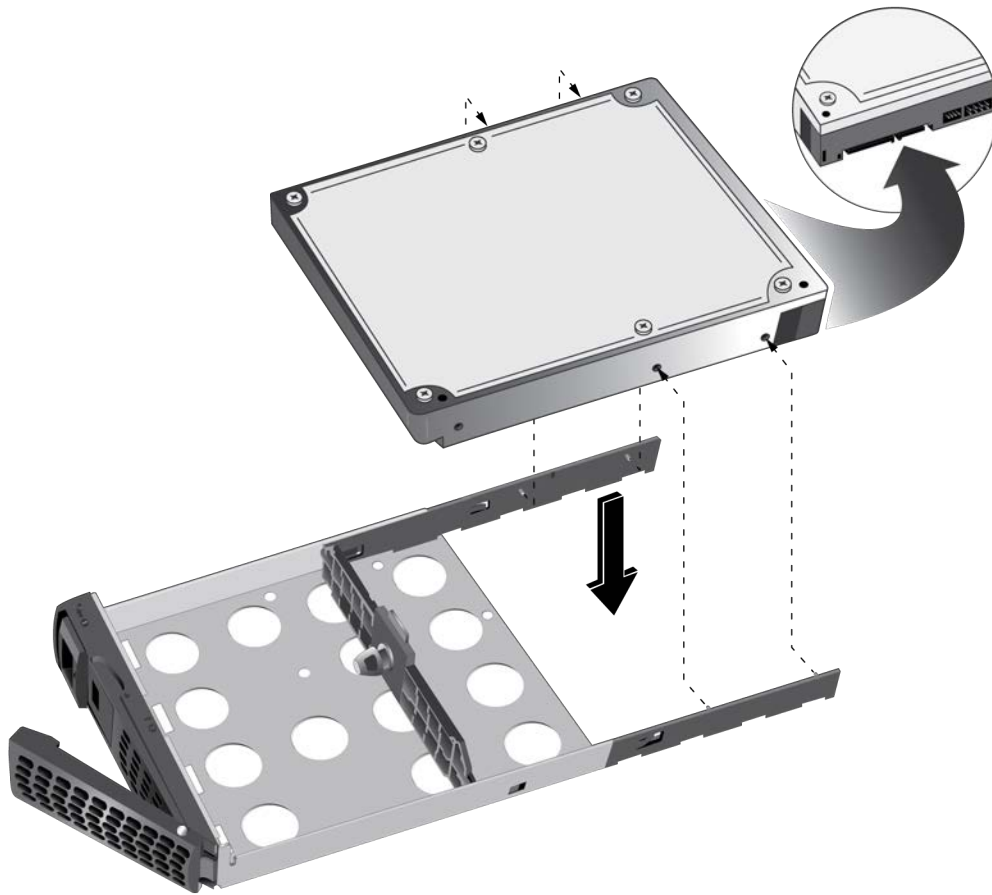

7. Push the mounting bracket and HDD back into the disk tray.



**WARNING:**

To prevent damage to your system, make sure that the disk tray is correctly oriented before inserting it into the drive bay.

8. Insert the disk tray back into the drive bay of the storage system.
  - For 2-bay and 4-bay systems, insert the disk tray so that the disk tray release latch is near the bottom of the system.
  - For 6-bay systems, insert the disk tray so that the disk tray release latch is on the left side of the system.
9. Press down on the disk tray handle until it latches closed.  
The disk tray is secured in the drive bay.
10. If necessary, turn on your system by pressing the **Power** button.  
If the disk that you added was not previously formatted, the system uses the disk in one of the following ways:

## ReadyNAS OS 6 Desktop Storage Systems

- If you are adding the disk to a system that uses X-RAID, the system automatically determines whether the disk is used for protection or storage. The new disk is incorporated in the background while you continue to use your system.
- If you are adding the disk to a system that uses Flex-RAID, the disk becomes available for use. You use the local admin page to manually configure the new disk.

For more information about X-RAID, Flex-RAID, and using the local admin page, see the *ReadyNAS OS 6 Software Manual*, which is available at [netgear.com/support/product/ReadyNAS\\_OS\\_6](http://netgear.com/support/product/ReadyNAS_OS_6).

### Add a 2.5-Inch Disk

#### ► To add a 2.5-inch hard disk drive (HDD) or 2.5-inch solid state drive (SSD):

1. Determine whether you must shut down your system:
  - If you are adding disks to a diskless system, gracefully shut down the system. For information about how to gracefully shut down your system, see the Preferred Shutdown section of the chapter that describes your system.
  - If your system is operating with one or more disks, you can add disks while the system is running. You do not need to shut down the system.
2. If necessary, slide the recessed handle lock to the unlocked position.
3. Press the disk tray release latch.

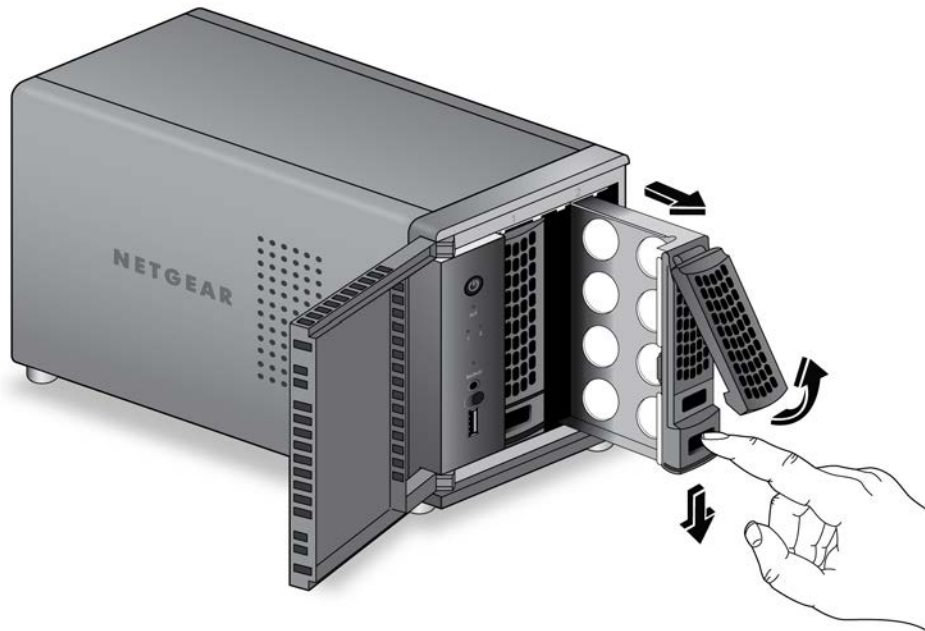

The disk tray handle pops out.

4. Pull out the disk tray.
5. Remove the mounting bracket from the disk tray:

## ReadyNAS OS 6 Desktop Storage Systems

- a. Press and hold the disk tray release latch.
- b. While holding the release latch, use your other hand to pull out one end of the mounting bracket and then the other until the ends extend slightly past the disk tray.

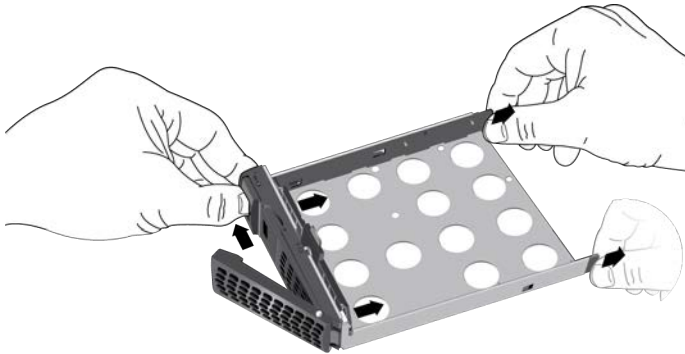

Make sure that the ends of the mounting bracket are even with each other.

- c. Slide the bracket down the disk tray, keeping both sides of the bracket even with each other.

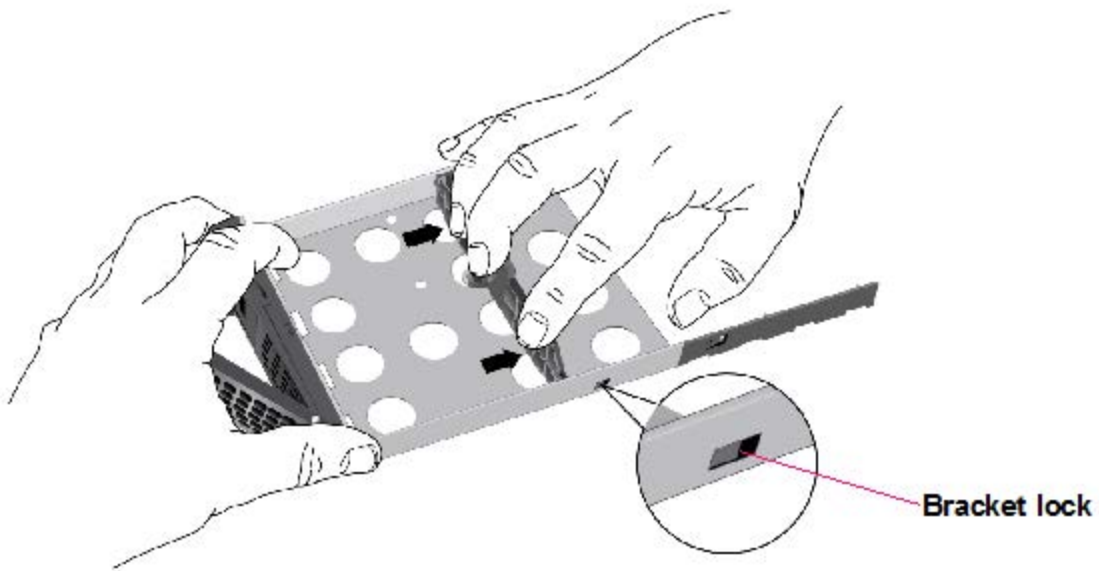

The mounting bracket stops when it hits the bracket lock.

The bracket lock prevents the mounting bracket from sliding all the way off the disk tray.

- d. Push the mounting bracket out of each bracket lock using a pointed object, such as a pen.

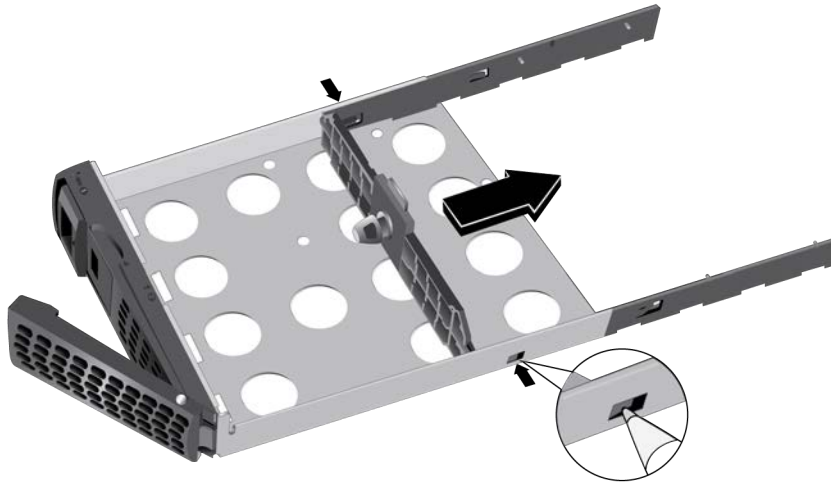

The mounting bracket is released from the bracket locks.

- e. Slide the mounting bracket out of the disk tray.  
The mounting bracket is not used to secure 2.5-inch HDDs or SSDs.
6. Place the new 2.5-inch HDD or SSD in the disk tray.
  7. Secure the HDD or SSD to the disk tray using the screws that came with your storage system.  
Make sure that the HDD or SSD connectors face the interior of the disk tray.

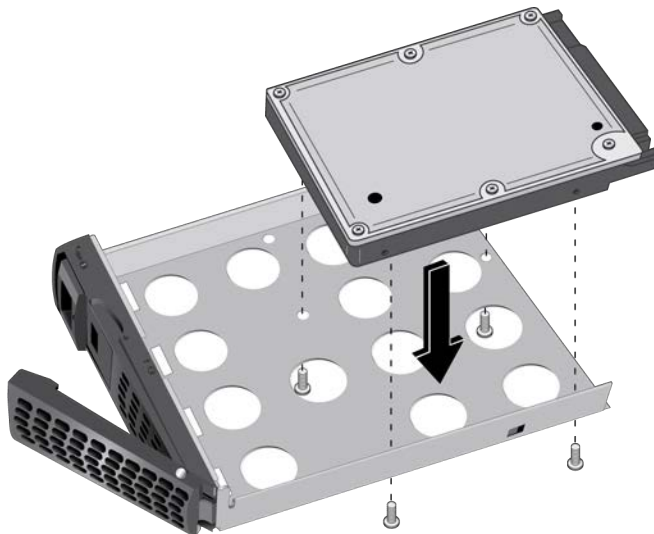

## ReadyNAS OS 6 Desktop Storage Systems

Make sure that the HDD or SSD is installed on the correct side of the disk tray.

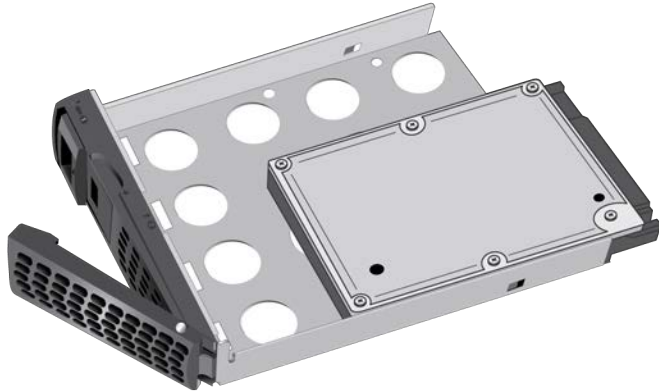

**WARNING:**

To prevent damage to your system, make sure that the disk tray is correctly oriented before inserting it into the drive bay.

8. Insert the disk tray back into the drive bay of the storage system.
  - For 2-bay and 4-bay systems, insert the disk tray so that the disk tray release latch is near the bottom of the system.
  - For 6-bay systems, insert the disk tray so that the disk tray release latch is on the left side of the system.
9. Press down on the disk tray handle until it latches closed.  
The disk tray is secured in the drive bay.
10. If necessary, turn on your system by pressing the Power button.  
If the disk that you added was not previously formatted, the system uses the disk in one of the following ways:
  - If you are adding the disk to a system that uses X-RAID, the system automatically determines whether the disk is used for protection or storage. The new disk is incorporated in the background while you continue to use your system.
  - If you are adding the disk to a system that uses Flex-RAID, the disk becomes available for use. You use the local admin page to manually configure the new disk.

For more information about X-RAID, Flex-RAID, and using the local admin page, see the *ReadyNAS OS 6 Software Manual*, which is available at [netgear.com/support/product/ReadyNAS\\_OS\\_6](http://netgear.com/support/product/ReadyNAS_OS_6).

## Replace a Disk

If your volumes use a protected RAID configuration, your system can recover from the failure of a disk. When you replace the failed disk, the system rebuilds the volume using the new disk and no data from the volume is lost.

The Disk LEDs can help you identify a failed disk. For more information, see the Status Information section of the chapter that describes your system. You can also use the local admin page to set up email alerts that notify you when a disk fails. In addition, the local admin page provides information about the failed disk.

For information about RAID configurations, setting up email alerts, and using the local admin page, see the *ReadyNAS OS 6 Software Manual*, which is available at [netgear.com/support/product/ReadyNAS\\_OS\\_6](http://netgear.com/support/product/ReadyNAS_OS_6).

ReadyNAS supports hot-swap drive bays, so you do not need to power down your storage system when replacing a disk.

If you are replacing a disk with a previously formatted disk, see the instructions in *Previously Formatted Disks* on page 165.



### **WARNING:**

**Replace one disk at a time. Wait for the volume to resynchronize your data before replacing another disk. If you attempt to replace more than one disk at a time, the system will crash.**

## Replace a 3.5-Inch Disk

### ► To replace a 3.5-inch hard disk drive (HDD):

1. If necessary, slide the recessed handle lock to the unlocked position.
2. Press the disk tray release latch.

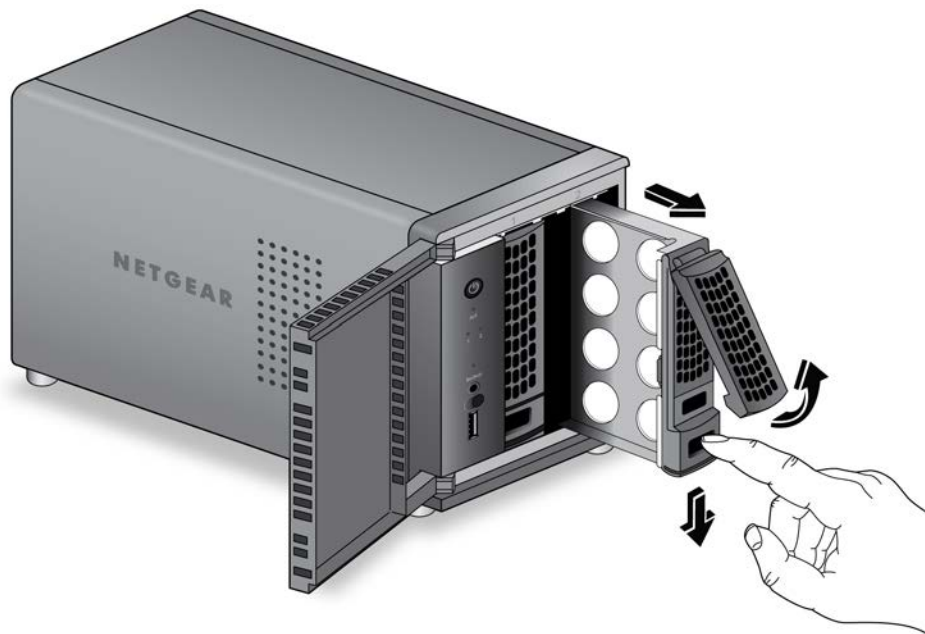

The disk tray handle pops out.

3. Pull out the disk tray.
4. Press and hold the disk tray release latch.

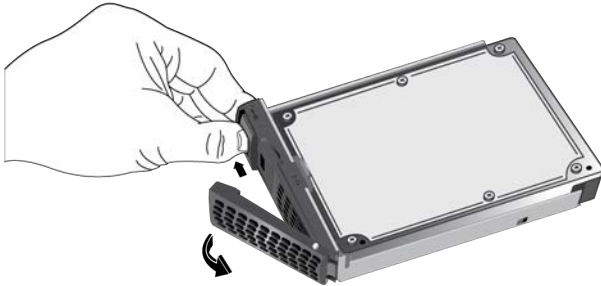

5. While holding the disk tray release latch, pull out the mounting bracket and slide the bracket down the tray.

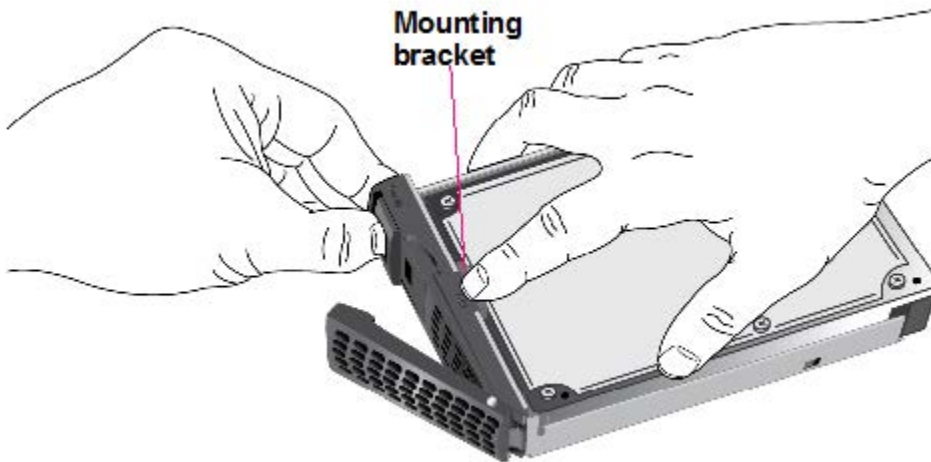

The mounting bracket stops when it hits the bracket lock.



## ReadyNAS OS 6 Desktop Storage Systems

The bracket lock prevents the mounting bracket from sliding all the way off the disk tray.

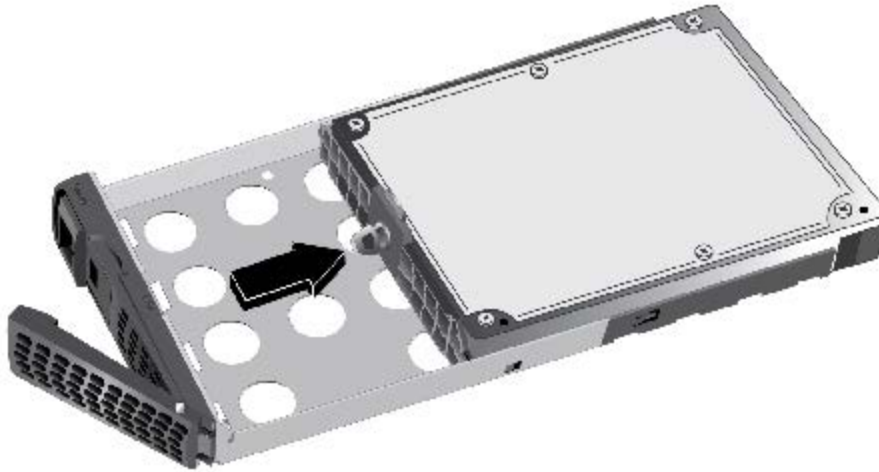

6. Remove the old HDD from the mounting bracket.
7. Attach the new HDD to the mounting bracket.

## ReadyNAS OS 6 Desktop Storage Systems

Make sure that the HDD mounting holes are aligned with the bracket's mounting posts and that the HDD connectors face the interior of the disk tray.

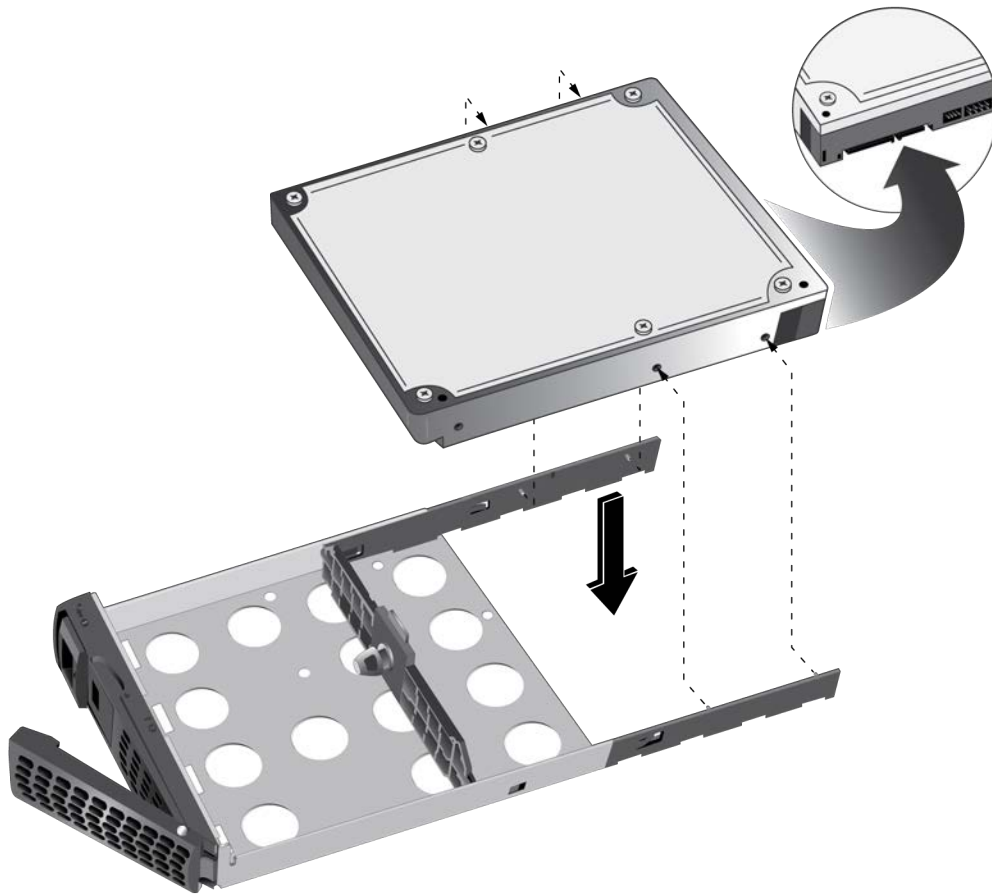

8. Push the mounting bracket and HDD back into the disk tray.



**WARNING:**

To prevent damage to your system, make sure that the disk tray is correctly oriented before inserting it into the drive bay.

9. Insert the disk tray back into the drive bay of the storage system.
  - For 2-bay and 4-bay systems, insert the disk tray so that the disk tray release latch is near the bottom of the system.
  - For 6-bay systems, insert the disk tray so that the disk tray release latch is on the left side of the system.
10. Press down on the disk tray handle until it latches closed.

The disk tray is secured in the drive bay.

If the volume that contained the failed disk uses a protected RAID configuration, the system automatically resynchronizes the volume using the new disk. Resynchronization might take several hours, depending on the disk size. You can continue to use your storage system, although access is slower until the volume resynchronization finishes.

For more information about RAID configurations, see the *ReadyNAS OS 6 Software Manual*, which is available at [netgear.com/support/product/ReadyNAS\\_OS\\_6](http://netgear.com/support/product/ReadyNAS_OS_6).

### Replace a 2.5-Inch Disk

► **To replace a 2.5-inch hard disk drive (HDD) or 2.5-inch solid state drive (SSD):**

1. If necessary, slide the recessed handle lock to the unlocked position.
2. Press the disk tray release latch.

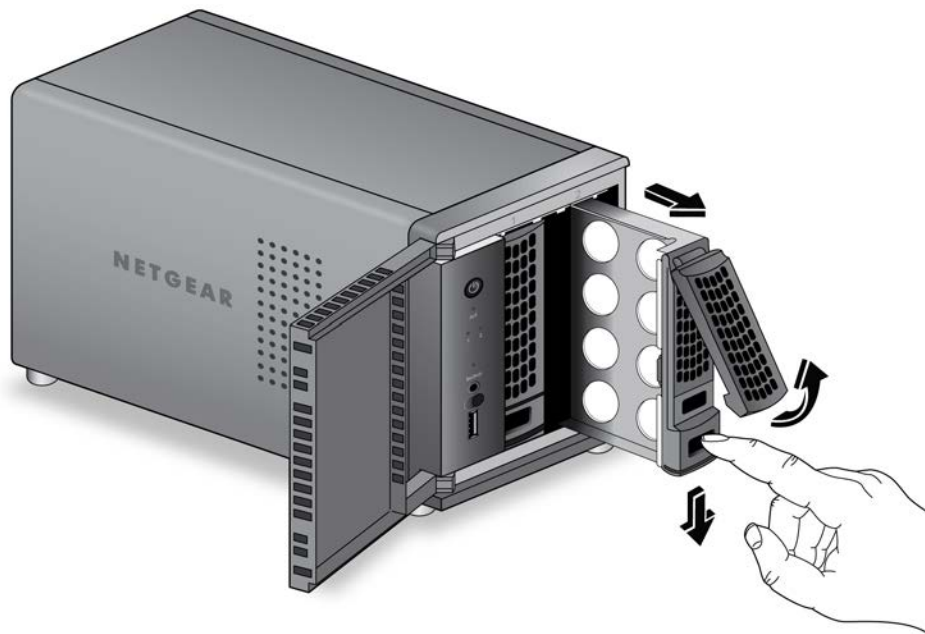

The tray handle pops out.

3. Pull out the disk tray.
4. Replace the 2.5-inch HDD or SSD:

## ReadyNAS OS 6 Desktop Storage Systems

- a. Remove the screws and the old 2.5-inch HDD or SSD.

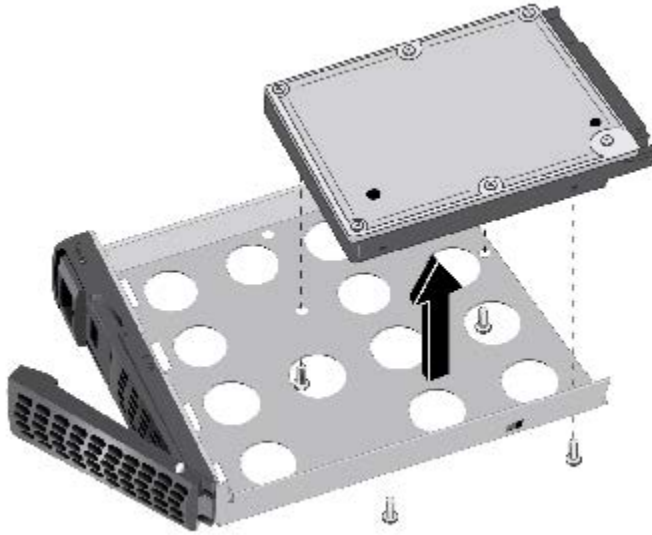

- b. Place the new 2.5-inch HDD or SSD in the disk tray.
- c. Secure the HDD or SSD to the disk tray using the screws.  
Make sure that the disk connectors face the interior of the disk tray.

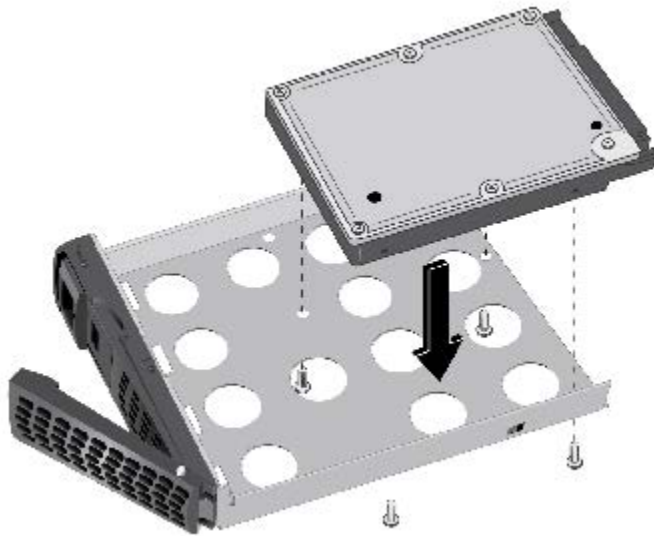

## ReadyNAS OS 6 Desktop Storage Systems

Make sure that the HDD or SSD is installed on the correct side of the disk tray.

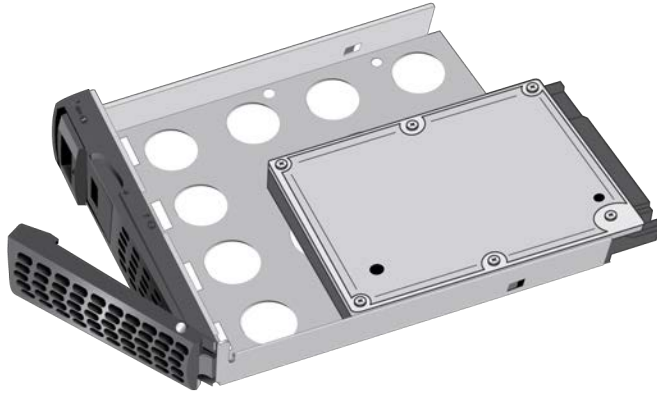

### **WARNING:**

**To prevent damage to your system, make sure that the disk tray is correctly oriented before inserting it into the drive bay.**

5. Insert the disk tray back into the drive bay of the storage system.
  - For 2-bay and 4-bay systems, insert the disk tray so that the disk tray release latch is near the bottom of the system.
  - For 6-bay systems, insert the disk tray so that the disk tray release latch is on the left side of the system.

6. Press down on the disk tray handle until it latches closed.  
The disk tray is secured in the drive bay.

If the volume that contained the failed disk uses a protected RAID configuration, the system automatically resynchronizes the volume using the new disk. Resynchronization might take several hours, depending on the disk size. You can continue to use your storage system, although access is slower until the volume resynchronization finishes.

For more information about RAID configurations, see the *ReadyNAS OS 6 Software Manual*, which is available at [netgear.com/support/product/ReadyNAS\\_OS\\_6](http://netgear.com/support/product/ReadyNAS_OS_6).

# Defaults and Technical Specifications

---

# A

This appendix includes the following sections:

- *Factory Default Settings* on page 184
- *ReadyNAS 102 Technical Specifications* on page 184
- *ReadyNAS 104 Technical Specifications* on page 186
- *ReadyNAS 202 Technical Specifications* on page 187
- *ReadyNAS 212 Technical Specifications* on page 188
- *ReadyNAS 204 Technical Specifications* on page 189
- *ReadyNAS 214 Technical Specifications* on page 191
- *ReadyNAS 312 Technical Specifications* on page 192
- *ReadyNAS 314 Technical Specifications* on page 193
- *ReadyNAS 316 Technical Specifications* on page 194
- *ReadyNAS 422 Technical Specifications* on page 196
- *ReadyNAS 424 Technical Specifications* on page 197
- *ReadyNAS 516 Technical Specifications* on page 201
- *ReadyNAS 524X Technical Specifications* on page 202
- *ReadyNAS 526X Technical Specifications* on page 204
- *ReadyNAS 528X Technical Specifications* on page 205
- *ReadyNAS 626X Technical Specifications* on page 206
- *ReadyNAS 628X Technical Specifications* on page 208
- *ReadyNAS 716X Technical Specifications* on page 209
- *EDA 500 Technical Specifications* on page 210
- *Safety Warnings* on page 211

## Factory Default Settings

The following table lists factory default settings for ReadyNAS OS 6 desktop storage systems.

**Table 20. ReadyNAS OS 6 factory default settings**

Feature	Default
Login	
Default IP address	The default IP address for the ReadyNAS is assigned by the local router (DHCP server).  If a router does not assign an IP address, the ReadyNAS defaults to the IP address https://169.254.x.x, where the last two octets are randomly generated based on the system's MAC address.
Admin user name (case-sensitive)	admin
Admin login password (case-sensitive)	password
Management	
System configuration	ReadyNAS local admin page web-based configuration and status monitoring
Discovery, setup, and multi-storage system status monitoring web	ReadyCloud for Windows, Mac, and Linux
LAN Connections	
MAC address	See product label
MTU size	1500
Ethernet port	Auto Sense 10/100/1000BASE-T, RJ-45
LAN IP address	DHCP acquired

## ReadyNAS 102 Technical Specifications

The ReadyNAS 102 storage system meets the following technical specifications:

### General:

- Marvell Armada 370 1.2 GHz CPU
- 512 MB memory
- Two-bay storage
- One eSATA port



- One USB 2.0 port (front)
- Two USB 3.0 ports (back)
- One GbE port

### Physical dimensions (h x w x d):

142 x 101 x 220 mm (5.60 x 3.98 x 8.70 in.)

### Physical weight:

2.12 kg (4.67 lb) without disks

### Power consumption:

- BTU at full power supply utilization: 31.7W
- In operation: 31W
- Power off (Wake On LAN): 1.0W
- Power off: 210 mW

### Electrical:

- External 60 W (12V, 5A) AC power supply
- Input: 100–240V AC, 50/60 Hz

### Environmental requirements:

- Operating temperature: 0 to 40°C (32° to 104°F)
- Operating humidity: 20 to 80% relative humidity (noncondensing)
- Storage temperature: –20 to 70°C (–4 to 158°F)
- Storage humidity: 5 to 95% relative humidity (noncondensing)
- Software-controlled 92 mm chassis cooling fan

### Certifications:

FCC Class B, CE Class B, RoHS, VCCI Class B

## ReadyNAS 104 Technical Specifications

The ReadyNAS 104 storage system meets the following technical specifications:

### General:

- Marvell Armada 370 1.2 GHz CPU
- 512 MB memory
- Four-bay storage
- One eSATA port
- One USB 2.0 port (front)
- Two USB 3.0 ports (back)
- Two GbE ports
- LCD display

### Physical dimensions (h x w x d):

205 x 134 x 223 mm (8.97 x 5.28 x 8.78 in.)

### Physical weight:

4.70 kg (10.36 lb) without disks

### Power consumption:

- BTU at full power supply utilization: 47W
- In operation: 45.6W
- Power off (Wake On LAN): 1.4W
- Power off: 0.44 W

### Electrical:

- External 90 W (12V, 7A) AC power supply
- Input: 100–240VAC, 50/60 Hz

## Environmental requirements:

- Operating temperature: 0 to 40°C (32° to 104°F)
- Operating humidity: 20 to 80% relative humidity (noncondensing)
- Storage temperature: –20 to 70°C (–4 to 158°F)
- Storage humidity: 5 to 95% relative humidity (noncondensing)
- Software-controlled 92 mm chassis cooling fan

## Certifications:

FCC Class B, CE Class B, RoHS, VCCI Class B

## ReadyNAS 202 Technical Specifications

The ReadyNAS 202 storage system meets the following technical specifications:

### General:

- Annapurna Labs AL212 1.4 GHz processor
- 2 GB memory
- Two-bay storage
- One eSATA port
- One USB 3.0 port (front)
- Two USB 3.0 ports (back)
- Two GbE ports

### Physical dimensions (h x w x d):

142 x 101 x 220 mm (5.60 x 3.98 x 8.70 in.)

### Physical weight:

2.12 kg (4.67 lb) without disks

### Power consumption:

- BTU at full power supply utilization: 39.5W
- In operation: 38W
- Power off (Wake On LAN): 1.31W

### Electrical:

- External 60 W (12V, 5A) AC power supply
- Input: 100–240 VAC, 50/60 Hz

### Environmental requirements:

- Operating temperature: 0 to 40°C (32° to 104°F)
- Operating humidity: 20 to 80% relative humidity (noncondensing)
- Storage temperature: –20 to 70°C (–4 to 158°F)
- Storage humidity: 5 to 95% relative humidity (noncondensing)
- Software-controlled 92 mm chassis cooling fan

### Certifications:

FCC Class B, CE Class B, RoHS, VCCI Class B, CCC

## ReadyNAS 212 Technical Specifications

The ReadyNAS 212 storage system meets the following technical specifications:

### General:

- Annapurna Labs AL214 1.4 GHz processor
- 2 GB memory
- Two-bay storage
- One eSATA port
- One USB 3.0 port (front)
- Two USB 3.0 ports (back)
- Two GbE ports

## Physical dimensions (h x w x d):

142 x 101 x 220 mm (5.60 x 3.98 x 8.70 in.)

## Physical weight:

2.12 kg (4.67 lb) without disks

## Power consumption:

- BTU at full power supply utilization: 39.5W
- In operation: 38W
- Power off (Wake On LAN): 1.31W

## Electrical:

- External 60W (12V, 5A) AC power supply
- Input: 100–240 VAC, 50/60 Hz

## Environmental requirements:

- Operating temperature: 0 to 40°C (32° to 104°F)
- Operating humidity: 20 to 80% relative humidity (noncondensing)
- Storage temperature: –20 to 70°C (–4 to 158°F)
- Storage humidity: 5 to 95% relative humidity (noncondensing)
- Software-controlled 92 mm chassis cooling fan

## Certifications:

FCC Class B, CE Class B, RoHS, VCCI Class B, CCC

## ReadyNAS 204 Technical Specifications

The ReadyNAS 204 storage system meets the following technical specifications:

### General:

- Annapurna Labs AL212 1.4 GHz processor
- 2 GB memory

- Four-bay storage
- One eSATA port
- One USB 2.0 port (front)
- Two USB 3.0 ports (back)
- Two GbE ports
- LCD display

### Physical dimensions (h x w x d):

205 x 134 x 223 mm (8.97 x 5.28 x 8.78 in.)

### Physical weight:

4.70 kg (10.36 lb) without disks

### Power consumption:

- BTU at full power supply utilization: 48.7W
- In operation: 46.8W
- Power off (Wake On LAN): 1.31W

### Electrical:

- External 90W (12V, 7A) AC power supply
- Input: 100–240 VAC, 50/60 Hz

### Environmental requirements:

- Operating temperature: 0 to 40°C (32° to 104°F)
- Operating humidity: 20 to 80% relative humidity (noncondensing)
- Storage temperature: –20 to 70°C (–4 to 158°F)
- Storage humidity: 5 to 95% relative humidity (noncondensing)
- Software-controlled 92 mm chassis cooling fan

### Certifications:

FCC Class B, CE Class B, RoHS, VCCI Class B, CCC

## ReadyNAS 214 Technical Specifications

The ReadyNAS 214 storage system meets the following technical specifications:

### General:

- Annapurna Labs AL214 1.4 GHz processor
- 2 GB memory
- Four-bay storage
- One eSATA port
- One USB 2.0 port (front)
- Two USB 3.0 ports (back)
- Two GbE ports
- LCD display

### Physical dimensions (h x w x d):

205 x 134 x 223 mm (8.97 x 5.28 x 8.78 in.)

### Physical weight:

4.70 kg (10.36 lb) without disks

### Power consumption:

- BTU at full power supply utilization: 48.7W
- In operation: 46.8W
- Power off (Wake On LAN): 1.31W

### Electrical:

- External 90W (12V, 7A) AC power supply
- Input: 100–240 VAC, 50/60 Hz

### Environmental requirements:

- Operating temperature: 0 to 40°C (32° to 104°F)
- Operating humidity: 20 to 80% relative humidity (noncondensing)

- Storage temperature: –20 to 70°C (–4 to 158°F)
- Storage humidity: 5 to 95% relative humidity (noncondensing)
- Software-controlled 92 mm chassis cooling fan

### Certifications:

FCC Class B, CE Class B, RoHS, VCCI Class B, CCC

## ReadyNAS 312 Technical Specifications

The ReadyNAS 312 storage system meets the following technical specifications:

### General:

- Intel Atom 2.1 GHz Dual Core CPU
- 2 GB memory
- Two-bay storage
- One eSATA port
- One HDMI port (not currently supported)
- One USB 2.0 port (front)
- Two USB 3.0 ports (back)
- Two LAN ports
- Infrared remote receiver

### Physical dimensions (h x w x d):

142 x 101 x 220 mm (5.60 x 3.98 x 8.70 in.)

### Physical weight:

2.22 kg (4.89 lb) without disks

### Power consumption:

- BTU at full power supply utilization: 50.58W
- In operation: 34.92W
- Power off (Wake On LAN): 627.07 mW
- Power off: 266.61 mW



### Electrical:

- External 60 W (12V, 5A) AC power supply
- Input: 100–240 VAC, 50/60 Hz

### Environmental requirements:

- Operating temperature: 0 to 40°C (32° to 104°F)
- Operating humidity: 20 to 80% relative humidity (noncondensing)
- Storage temperature: –20 to 70°C (–4 to 158°F)
- Storage humidity: 5 to 95% relative humidity (noncondensing)
- Software-controlled 92 mm chassis cooling fan

### Certifications:

FCC Class B, CE Class B, RoHS, VCCI Class B

## ReadyNAS 314 Technical Specifications

The ReadyNAS 314 storage system meets the following technical specifications:

### General:

- Intel Atom 2.1 GHz Dual Core CPU
- 2 GB memory
- Four-bay storage
- Two eSATA ports (one shared USB 2.0 and eSATA port)
- One HDMI port (not currently supported)
- One USB 2.0 port (front)
- Two USB 3.0 ports (back)
- Two LAN ports
- LCD display
- Infrared remote receiver

### Physical dimensions (h x w x d):

205 x 134 x 223 mm (8.97 x 5.28 x 8.78 in.)

## Physical weight:

3.97 kg (8.75 lb) without disks

## Power consumption:

- BTU at full power supply utilization: 69.45W
- In operation: 48.71 W
- Power off (Wake On LAN): 843.36 mW
- Power off: 472.77 mW

## Electrical:

- External 90W (12V, 7A) AC power supply
- Input: 100–240 VAC, 50/60 Hz

## Environmental requirements:

- Operating temperature: 0 to 40°C (32° to 104°F)
- Operating humidity: 20 to 80% relative humidity (noncondensing)
- Storage temperature: –20 to 70°C (–4 to 158°F)
- Storage humidity: 5 to 95% relative humidity (noncondensing)
- Software-controlled 92 mm chassis cooling fan

## Certifications:

FCC Class B, CE Class B, RoHS, VCCI Class B

## ReadyNAS 316 Technical Specifications

The ReadyNAS 316 storage system meets the following technical specifications:

### General:

- Intel Atom 2.1 GHz Dual Core CPU
- 2 GB memory
- Six-bay storage
- Two eSATA ports

- One HDMI port (not currently supported)
- One USB 2.0 port (front)
- Two USB 3.0 ports (back)
- Two LAN ports
- LCD display
- Infrared remote receiver
- Proximity sensor

### Physical dimensions (h x w x d):

259 x 192 x 287.5 mm (10.20 x 7.56 x 11.32 in.)

### Physical weight:

7.49 kg (16.50 lb) without disks

### Power consumption:

- BTU at full power supply utilization: 110.66W
- In operation: 54.94W
- Power off (Wake On LAN): 804.64 mW
- Power off: 338.42 mW

### Electrical:

- Internal 200W server-rated AC power supply
- Input: 100-240 VAC, 50/60 Hz

### Environmental requirements:

- Operating temperature: 0 to 40°C (32° to 104°F)
- Operating humidity: 20 to 80% relative humidity (noncondensing)
- Storage temperature: -20 to 70°C (-4 to 158°F)
- Storage humidity: 5 to 95% relative humidity (noncondensing)
- Software-controlled 120 mm chassis cooling fan

## Certifications:

FCC Class B, CE Class B, RoHS, VCCI Class B

## ReadyNAS 422 Technical Specifications

The ReadyNAS 422 storage system meets the following technical specifications:

### General:

- Intel Atom C3338 Dual Core Processor
- 2 GB DDR4 memory
- Two-bay storage
- One eSATA port
- Two USB 3.0 ports (one on the front and one on the back)
- Two 1 GbE LAN ports
- One micro USB console connector (marked as UART)
- OLED display

### Physical dimensions (h x w x d):

194 x 135.5 x 239 mm (7.64 x 5.3 x 9.4 in.)

### Physical weight:

3.52 kg (7.76 lb) without disks

### Power consumption:

- BTU at full power supply utilization: 40.15W
- In operation: 34.86W
- Power off (Wake On LAN): 4.5W
- Power off: 270 mW

### Electrical:

- External 60W AC power supply
- Input: 100–240 VAC, 50/60 Hz

### Environmental requirements:

- Operating temperature: 0 to 45°C (32° to 113°F)
- Operating humidity: 20 to 80% relative humidity (noncondensing)
- Storage temperature: –20 to 70°C (–4 to 158°F)
- Storage humidity: 5 to 95% relative humidity (noncondensing)
- Software-controlled 92 mm chassis cooling fan

### Certifications:

FCC Class B, CE Class B, RoHS, VCCI Class B

## ReadyNAS 424 Technical Specifications

The ReadyNAS 424 storage system meets the following technical specifications:

### General:

- Intel Atom C3338 Dual Core Processor
- 2 GB DDR4 memory
- Four-bay storage
- One eSATA port
- Two USB 3.0 ports (one on the front and one on the back)
- Two 1 GbE LAN ports
- One micro USB console connector (marked as UART)
- OLED display

### Physical dimensions (h x w x d):

194 x 185 x 239 mm (7.64 x 7.3 x 9.4 in.)

### Physical weight:

3.95 kg (8.7 lb) without disks

### Power consumption:

- BTU at full power supply utilization: 57.4W
- In operation: 43.09W
- Power off (Wake On LAN): 4.4W
- Power off: 400 mW

### Electrical:

- External 90W AC power supply
- Input: 100–240 VAC, 50/60 Hz

### Environmental requirements:

- Operating temperature: 0 to 45°C (32° to 113°F)
- Operating humidity: 20 to 80% relative humidity (noncondensing)
- Storage temperature: –20 to 70°C (–4 to 158°F)
- Storage humidity: 5 to 95% relative humidity (noncondensing)
- Software-controlled 120 mm chassis cooling fan

### Certifications:

FCC Class B, CE Class B, RoHS, VCCI Class B

## ReadyNAS 426 Technical Specifications

The ReadyNAS 426 storage system meets the following technical specifications:

### General:

- Intel Atom C3538 Quad Core Processor, 2.1 GHz
- 4 GB DDR4 memory
- Six-bay storage
- One eSATA port
- One USB 3.0 port (front)
- One USB 3.0 port (back)
- Four 1 GbE LAN ports

- One micro USB console connector (marked as UART)
- OLED display

### Physical dimensions (h x w x d):

259 x 192 x 277 mm (10.2 x 7.55 x 10.9 in.)

### Physical weight:

7.43 kg (16.38 lb) without disks

### Power consumption:

- BTU at full power supply utilization: 68.57W
- In operation: 63.11W
- Power off (Wake On LAN): 4.313W
- Power off: 189 mW

### Electrical:

- Internal 200W server-rated AC power supply
- Input: 100–240 VAC, 50/60 Hz

### Environmental requirements:

- Operating temperature: 0 to 45°C (32° to 113°F)
- Operating humidity: 20 to 80% relative humidity (noncondensing)
- Storage temperature: –20 to 70°C (–4 to 158°F)
- Storage humidity: 5 to 95% relative humidity (noncondensing)
- Software-controlled 120 mm chassis cooling fan

### Certifications:

FCC Class B, CE Class B, RoHS, VCCI Class B, CCC, MIC, BIS

## ReadyNAS 428 Technical Specifications

The ReadyNAS 428 storage system meets the following technical specifications:

### General:

- Intel Atom C3538 Quad Core Processor, 2.1 GHz
- 4 GB DDR4 memory
- Eight-bay storage
- One eSATA port
- One USB 3.0 port (front)
- One USB 3.0 port (back)
- Four 1 GbE LAN ports
- One micro USB console connector (marked as UART)
- OLED display

### Physical dimensions (h x w x d):

310 x 192 x 278 mm (12.2 x 7.55 x 10.94 in.)

### Physical weight:

9.01 kg (19.86 lb) without disks

### Power consumption:

- BTU at full power supply utilization: 91.47W
- In operation: 78.15W
- Power off (Wake On LAN): 3.995W
- Power off: 189 mW

### Electrical:

- Internal 200W server-rated AC power supply
- Input: 100–240 VAC, 50/60 Hz



### Environmental requirements:

- Operating temperature: 0 to 45°C (32° to 113°F)
- Operating humidity: 20 to 80% relative humidity (noncondensing)
- Storage temperature: –20 to 70°C (–4 to 158°F)
- Storage humidity: 5 to 95% relative humidity (noncondensing)
- Two software-controlled 92 mm chassis cooling fans

### Certifications:

FCC Class B, CE Class B, RoHS, VCCI Class B, CCC, MIC, BIS

## ReadyNAS 516 Technical Specifications

The ReadyNAS 516 storage system meets the following technical specifications:

### General:

- Intel Core i3 3.3 GHz Dual Core CPU
- 4 GB ECC memory
- Six-bay storage
- Three eSATA ports
- One HDMI port
- One USB 2.0 port (front)
- Two USB 3.0 ports (back)
- Two LAN ports
- LCD display
- Infrared remote receiver
- Proximity sensor

### Physical dimensions (h x w x d):

259 x 192 x 287.5 mm (10.20 x 7.56 x 11.32 in.)

### Physical weight:

8.00 kg (17.60 lb) without disks

### Power consumption:

- BTU at full power supply utilization: 153.54W
- In operation: 87.69W
- Power off (Wake On LAN): 798.08 mW
- Power off: 416.77 mW

### Electrical:

- Internal 200W server-rated AC power supply
- Input: 100–240 VAC, 50/60 Hz

### Environmental requirements:

- Operating temperature: 0 to 40°C (32° to 104°F)
- Operating humidity: 20 to 80% relative humidity (noncondensing)
- Storage temperature: –20 to 70°C (–4 to 158°F)
- Storage humidity: 5 to 95% relative humidity (noncondensing)
- Software-controlled 120 mm chassis cooling fan

### Certifications:

FCC Class B, CE Class B, RoHS, VCCI Class B

## ReadyNAS 524X Technical Specifications

The ReadyNAS 524X storage system meets the following technical specifications:

### General:

- Intel Pentium processor D-1508
- 4 GB ECC DDR4 memory
- Four-bay storage
- One eSATA port
- One USB 3.0 port (front)
- Two USB 3.0 ports (back)
- One 1 GbE LAN port
- One 10 GbE LAN port

- One micro USB console connector (marked as UART)
- OLED display

### Physical dimensions (h x w x d):

194 x 185 x 239 mm (7.64 x 7.28 x 9.4 in.)

### Physical weight:

4.53 kg (10.0 lb) without disks

### Power consumption:

- BTU at full power supply utilization: 74.9W
- In operation: 41.9W
- Power off (Wake On LAN): 5.3W
- Power off: 204 mW

### Electrical:

- External 120W AC power supply
- Input: 100–240 VAC, 50/60 Hz

### Environmental requirements:

- Operating temperature: 0 to 40°C (32° to 104°F)
- Operating humidity: 20 to 80% relative humidity (noncondensing)
- Storage temperature: –20 to 70°C (–4 to 158°F)
- Storage humidity: 5 to 95% relative humidity (noncondensing)
- Software-controlled 92 mm or 120 mm chassis cooling fan

### Certifications:

FCC Class B, CE Class B, RoHS, VCCI Class B, CCC, MIC, BIS

## ReadyNAS 526X Technical Specifications

The ReadyNAS 526X storage system meets the following technical specifications:

### General:

- Intel Pentium processor D-1508
- 4 GB ECC DDR4 memory
- Six-bay storage
- One eSATA port
- One USB 3.0 port (front)
- Two USB 3.0 ports (back)
- Two 10 GbE LAN ports
- OLED display

### Physical dimensions (h x w x d):

260 x 190 x 280 mm (10.24 x 7.48 x 11.02 in.)

### Physical weight:

7.9 kg (17.4 lb) without disks

### Power consumption:

- BTU at full power supply utilization: 100W
- In operation: 70.5W
- Power off (Wake On LAN): 310 mW
- Power off: 264 mW

### Electrical:

- Internal 200W server-rated AC power supply
- Input: 100–240 VAC, 50/60 Hz

### Environmental requirements:

- Operating temperature: 0 to 40°C (32° to 104°F)
- Operating humidity: 20 to 80% relative humidity (noncondensing)
- Storage temperature: –20 to 70°C (–4 to 158°F)
- Storage humidity: 5 to 95% relative humidity (noncondensing)
- Software-controlled 120 mm chassis cooling fan

### Certifications:

FCC Class B, CE Class B, RoHS, VCCI Class B, CCC, MIC, BIS

## ReadyNAS 528X Technical Specifications

The ReadyNAS 528X storage system meets the following technical specifications:

### General:

- Intel Pentium processor D-1508
- 4 GB ECC DDR4 memory
- Eight-bay storage
- One eSATA port
- One USB 3.0 port (front)
- Two USB 3.0 ports (back)
- Two 10 GbE LAN ports
- One micro USB console connector (marked as UART)
- OLED display

### Physical dimensions (h x w x d):

319 x 192 x 289 mm (12.56 x 7.56 x 11.38 in.) with feet

### Physical weight:

9.35 kg (20.61 lb) without disks

### Power consumption:

- BTU at full power supply utilization: 104.3W
- In operation: 82.2W
- Power off (Wake On LAN): 344 mW
- Power off: 341 mW

### Electrical:

- Internal 250W server-rated AC power supply
- Input: 100–240 VAC, 50/60 Hz

### Environmental requirements:

- Operating temperature: 0 to 40°C (32° to 104°F)
- Operating humidity: 20 to 80% relative humidity (noncondensing)
- Storage temperature: –20 to 70°C (–4 to 158°F)
- Storage humidity: 5 to 95% relative humidity (noncondensing)
- Software-controlled 120 mm chassis cooling fan

### Certifications:

FCC Class B, CE Class B, RoHS, VCCI Class B, CCC, MIC, BIS

## ReadyNAS 626X Technical Specifications

The ReadyNAS 626X storage system meets the following technical specifications:

### General:

- Intel Xeon processor D-1521
- 8 GB ECC DDR4 memory
- Six-bay storage
- One eSATA port
- One USB 3.0 port (front)
- Two USB 3.0 ports (back)
- Two 1 GbE LAN ports

- Two 10 GbE LAN ports
- OLED display

### Physical dimensions (h x w x d):

260 x 190 x 280 mm (10.24 x 7.48 x 11.02 in.)

### Physical weight:

7.9 kg (17.4 lb) without disks

### Power consumption:

- BTU at full power supply utilization: 100W
- In operation: 70.5W
- Power off (Wake On LAN): 310 mW
- Power off: 264 mW

### Electrical:

- Internal 200W server-rated AC power supply
- Input: 100–240 VAC, 50/60 Hz

### Environmental requirements:

- Operating temperature: 0 to 40°C (32° to 104°F)
- Operating humidity: 20 to 80% relative humidity (noncondensing)
- Storage temperature: –20 to 70°C (–4 to 158°F)
- Storage humidity: 5 to 95% relative humidity (noncondensing)
- Software-controlled 120 mm chassis cooling fan

### Certifications:

FCC Class B, CE Class B, RoHS, VCCI Class B, CCC, MIC, BIS

## ReadyNAS 628X Technical Specifications

The ReadyNAS 628X storage system meets the following technical specifications:

### General:

- Intel Xeon processor D-1521
- 8 GB ECC DDR4 memory
- Eight-bay storage
- One eSATA port
- One USB 3.0 port (front)
- Two USB 3.0 ports (back)
- Two 1 GbE LAN ports
- Two 10 GbE LAN ports
- One micro USB console connector (marked as UART)
- OLED display

### Physical dimensions (h x w x d):

319 x 192 x 289 mm (12.56 x 7.56 x 11.38 in.) with feet

### Physical weight:

9.35 kg (20.61 lb) without disks

### Power consumption:

- BTU at full power supply utilization: 104.3W
- In operation: 82.2W
- Power off (Wake On LAN): 344 mW
- Power off: 341 mW

### Electrical:

- Internal 250W server-rated AC power supply
- Input: 100–240 VAC, 50/60 Hz



### Environmental requirements:

- Operating temperature: 0 to 40°C (32° to 104°F)
- Operating humidity: 20 to 80% relative humidity (noncondensing)
- Storage temperature: –20 to 70°C (–4 to 158°F)
- Storage humidity: 5 to 95% relative humidity (noncondensing)
- Software-controlled 120 mm chassis cooling fan

### Certifications:

FCC Class B, CE Class B, RoHS, VCCI Class B, CCC, MIC, BIS

## ReadyNAS 716X Technical Specifications

The ReadyNAS 716X storage system meets the following technical specifications:

### General:

- Intel Xeon processor E3-1265L v2 CPU
- 16 GB ECC memory
- Six-bay storage
- Three eSATA ports
- One HDMI port
- One USB 2.0 port (front)
- Two USB 3.0 ports (back)
- Two 1 GbE LAN ports
- Two 10 GbE LAN ports
- LCD display
- Infrared remote receiver
- Proximity sensor

### Physical dimensions (h x w x d):

259 x 192 x 287.5 mm (10.20 x 7.56 x 11.32 in.)

### Physical weight:

8.20 kg (18.04 lb) without disks

### Power consumption:

- BTU at full power supply utilization: 172.79W
- In operation: 96.15W
- Power off (Wake On LAN): 799.89 mW
- Power off: 419.62 mW

### Electrical:

- Internal 200W server-rated AC power supply
- Input: 100–240 VAC, 50/60 Hz

### Environmental requirements:

- Operating temperature: 0 to 40°C (32° to 104°F)
- Operating humidity: 20 to 80% relative humidity (noncondensing)
- Storage temperature: –20 to 70°C (–4 to 158°F)
- Storage humidity: 5 to 95% relative humidity (noncondensing)
- Software-controlled 120 mm chassis cooling fan

### Certifications:

FCC Class B, CE Class B, RoHS, VCCI Class B

## EDA 500 Technical Specifications

The EDA 500 storage system meets the following technical specifications:

### General:

- Five-bay storage
- One eSATA port
- Proximity sensor

### Physical dimensions (h x w x d):

259 x 192 x 287.5 mm (10.20 x 7.56 x 11.32 in.)

### Physical weight:

7.3 kg (16.1 lb) without disks

### Power consumption:

- BTU at full power supply utilization: 88.17W
- In operation: 37.3W
- Power off: 453.8 mW

### Electrical:

- Internal 200W server-rated AC power supply
- Input: 100–240 VAC, 50/60 Hz

### Environmental requirements:

- Operating temperature: 0 to 40°C (32° to 104°F)
- Operating humidity: 20 to 80% relative humidity (noncondensing)
- Storage temperature: –20 to 70°C (–4 to 158°F)
- Storage humidity: 5 to 95% relative humidity (noncondensing)
- Software controlled 120 mm chassis cooling fan

### Certifications:

FCC Class B, CE Class B, RoHS, VCCI Class B

## Safety Warnings

- The equipment contains no operator access areas and is certified for installation only by trained personnel, according to the installation instructions provided with each storage system.
- Install the socket-outlet near the equipment in an easily accessible location.
- Observe the on-board battery precautions.

---

**Note** Risk of explosion if battery is replaced by an incorrect type. Dispose of used batteries according to their instructions.

---

- Connect the storage systems and their associated LAN connections only to equipment within the same building.

### Electrical Safety Precautions

Follow basic electrical safety precautions to protect yourself from harm and the ReadyNAS from damage:

- Be aware of the locations of the power on/off switch on the chassis as well as the rooms emergency power-off switch, disconnection switch, or electrical outlet. If an electrical accident occurs, you can then quickly remove power from the system.
- Do not work alone when working with high-voltage components.
- Always disconnect power from the system when removing or installing main system components, such as the main board or memory modules. When disconnecting power, first power down the system with the operating system and then unplug the power cords of all the power supply storage systems in the system.
- When working around exposed electrical circuits, ensure that another person who is familiar with the power-off controls is nearby to switch off the power if necessary.
- Use only one hand when working with powered-on electrical equipment. This is to avoid making a complete circuit, which will cause electrical shock. Use extreme caution when using metal tools, which can easily damage any electrical components or circuit boards they come into contact with.
- Do not use mats designed to decrease static electrical discharge as protection from electrical shock. Instead, use rubber mats that have been specifically designed as electrical insulators.
- Use only power supply cords that include a grounding plug and plug them into grounded electrical outlets.

### General Safety Precautions

Follow these rules to ensure general safety:

- Keep the area around the ReadyNAS clean and free of clutter.
- See the technical specifications in this manual for details about your specific ReadyNAS storage systems.
- Replace the on-board battery only with the same battery or an equivalent type of battery recommended by the manufacturer. Dispose of used batteries according to the manufacturer's instructions.

---

**Note** Installing the battery upside down reverses its polarities and creates a danger of explosion.

---

- Only trained service technicians can replace the soldered-in self-resetting PTC (positive temperature coefficient) fuses on the main board, using only new fuses that are the same as or equivalent to the ones being replaced. Contact technical support for details and support.

### Electrostatic Discharge Precautions

Electrostatic discharge (ESD) is generated by two objects with different electrical charges coming into contact with each other. An electrical discharge is created to neutralize this difference, which can damage electronic components and printed circuit boards. The following measures are generally sufficient to neutralize this difference before contact is made to protect your equipment from ESD:



- Use a grounded wrist strap designed to prevent static discharge.
- Keep all components and printed circuit boards (PCBs) in their antistatic bags until ready for use.
- Touch a grounded metal object before removing the board from the antistatic bag.
- Do not let components or PCBs come into contact with your clothing, which might retain a charge even if you are wearing a wrist strap.
- Handle a board by its edges only; do not touch its components, peripheral chips, memory modules, or contacts.
- When handling chips or modules, avoid touching their pins.
- Put the main board and peripherals back into their antistatic bags when not in use.
- For grounding purposes, make sure your computer chassis provides excellent conductivity between the power supply, the case, the mounting fasteners, and the main board.